

Ci sono molti modi
per realizzare le tue idee,
le nostre tecnologie
ed i nostri chef
ti possono aiutare.

*There are many ways to fulfill your ideas,
our technologies and our chefs can help you.*

www.arriscateringequipment.it



INDICE / INDEX

CHI SIAMO / ABOUT US	p. 04
LA NOSTRA TECNOLOGIA / OUR TECHNOLOGY	p. 05
GRILLVAPOR ELETTRICO / ELECTRIC	p. 08
GRILLVAPOR GAS	p. 09
GRILLVAPOR ELETTRONICO / DIGIT	p. 11
RENDIAMO FACILE IL TUO LAVORO QUOTIDIANO WE LIGHTEN THE DAILY WORKLOAD	p. 13
SICUREZZA / SAFETY	p. 14
OVERGRILL	p. 16
GRILLVAPOR DIGIT	p. 24
FRY TOP GREEN ENERGY	p. 34
GRILLVAPOR POWER	p. 38
GRILLVAPOR MECCANICO	p. 46
GRILLVAPOR COMPACT	p. 58
KEEP COOL GRILL FAST	p. 66
ARRIS AGER	p. 70





CHI SIAMO/ABOUT US

Arris Catering Equipment® è un'azienda leader nella produzione di griglie professionali a gas ed elettriche. I nostri prodotti sono realizzati con materiali di alta qualità, costantemente collaudati nella fase produttiva, conformi alle leggi e norme vigenti in materia di sicurezza, igiene e prevenzione, certificati secondo le direttive CEE.

La nostra storia:

- 1993** - La famiglia Calzavara, ideatrice della tecnologia brevettata Grillvapor®, fonda Arris Catering Equipment
- 1996** - Cambio sede ed aumento unità produttiva.
- 2007** - Ampliamento dell'unità produttiva nella sede attuale di Cadoneghe.
- 2012** - Vengono progettate e prodotte le prime griglie a gas ed elettriche in versione digitale.
- 2013** - Viene introdotto Overgrill®, un nuovo modello di griglia che, sempre utilizzando la tecnologia Grillvapor®, cambia ancora una volta il modo di cucinare velocizzando i tempi di cottura e diminuendo i costi di manodopera in cucina.
- 2014** - Introduzione degli chef Arris al fine di migliorare e personalizzare il servizio di consulenza verso il cliente finale e in supporto dei concessionari.
- 2016** - Viene completamente riprogettato Overgrill® per un aumento della produttività con gli stessi consumi e una maggiore facilità di pulizia.
- 2019** - Viene integrata la gamma dei prodotti di cottura con la produzione dei fry-top a basso consumo di energia

Arris Catering Equipment® is a leading name in the production of professional gas and electric grills. Our products are made with high quality materials, tested continually during the course of manufacture, responding to current statutory regulations and standards on safety, hygiene and accident prevention, and certified in accordance with EEC directives.

Our history:

- 1993** - Arris Catering Equipment is founded by the Calzavara family, the inventor of Grillvapor® patent technology
- 1996** - Move to new premises and enlargement of production facility
- 2007** - Enlargement of production facility at the current premises of Cadoneghe
- 2012** - Design and production of the first gas and electric grills made in digital version
- 2013** - Introduction of the new model called Overgrill®, which still uses the Grillvapor® technology, but with faster cooking times and less labour costs in the kitchen.
- 2014** - Introduction of Arris chefs, with the aim of improving and customizing advice offered to the end user and maximizing support provided to dealers
- 2016** - Complete redesign of Overgrill® with the aim of increase the productivity, the consumption being equal, and the ease of cleaning.
- 2019** - The range of products will be improved with the production of low consumption fry-top

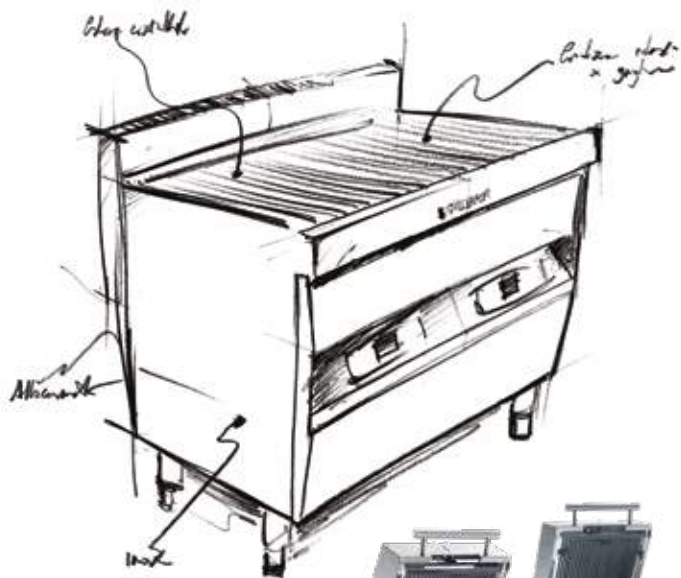

GRILLVAPOR®

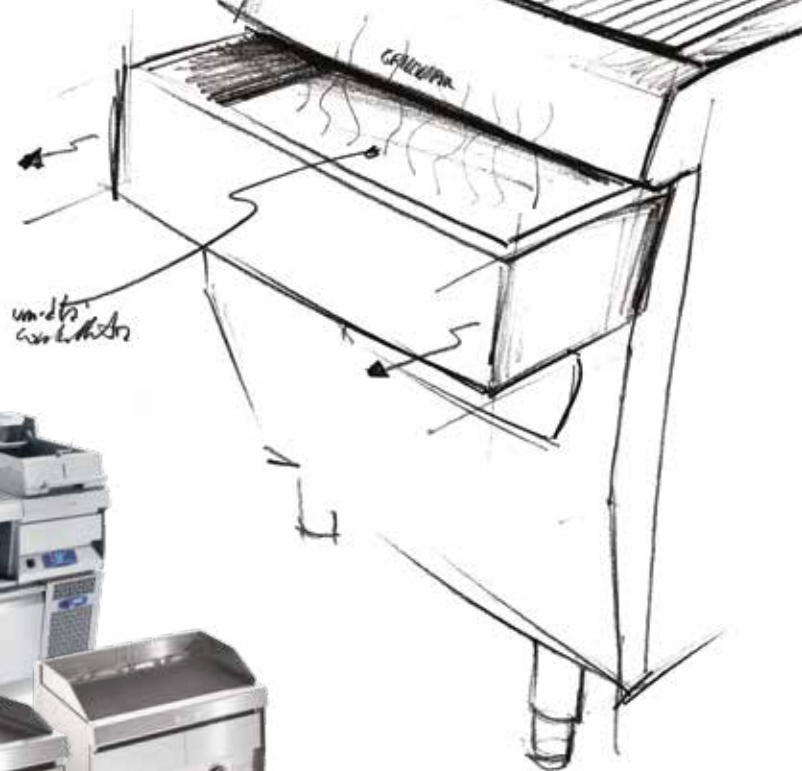

LA NOSTRA TECNOLOGIA / OUR TECHNOLOGY

Arris Catering Equipment® ha ideato e brevettato il sistema di cottura GRILLVAPOR® che combina **alte temperature**, precisamente controllabili, alla leggera idratazione delle superfici di cottura. Questo particolare sistema si basa sul processo di osmosi che avviene tra l'ambiente di cottura e gli alimenti e, di fatto, crea le condizioni ideali per la grigliatura ottenendo il **miglior risultato possibile**.

Il nostro obiettivo è quello di ottenere una **croccantezza** esterna pur **mantenendo all'interno i liquidi e i nutrienti propri dell'alimento stesso**.

La tecnologia GRILLVAPOR® che noi applichiamo alle nostre apparecchiature è l'unica che permette di ottenere i seguenti benefici sugli alimenti:

- Migliori risultati di cottura (rispetto a forni, piastre, pietra lavica, etc.)
- Minore calo peso del cibo (in media -20%)
- Rispetto delle proprietà organolettiche (i nutrienti rimangono all'interno)
- Cotture più veloci (+20%)
- Elimina l'uso di oli e grassi di condimento
- Colori degli alimenti più vivi e brillanti

Le nostre innovazioni tecniche vi permettono i seguenti benefici economici:

- Risparmio costi manodopera
- Risparmio energetico
- Uniformità di temperatura sul piano di cottura
- Facile pulizia
- Migliore assorbimento dello shock termico
- Gestione delle temperature con la sonda al cuore
- Migliori sistemi di sicurezza

Arris Catering Equipment® created and patented the GRILLVAPOR® cooking system, which combines **high temperatures** — allowing precision control — with a slight humidification of cooking surfaces. This particular system is based on the process of osmosis brought about between the cooking environment and the foods, which in effect creates the ideal conditions for grilling, and gives **the best results possible**.

Our aim is to cook foods in such a way that they will **becrispy** on the outside while retaining all of their **natural juices and nutrients** on the inside.

The GRILLVAPOR® technology incorporated into our appliances is the only one able to provide the following benefits:

- Better cooking results (compared to ovens, fry-top, lava stone grills, etc.)
- Less weight loss in cooking (-20% on average)
- Retention of organoleptic properties (nutrients remain inside)
- Faster cooking (+20%)
- No use of oils and fats for seasoning
- Food colours remain sharp and bright

Our engineering innovations provide the following economic benefits:

- Savings on labour costs
- Savings on energy
- Uniform temperature across the cook-top
- Easy cleaning
- Better absorption of thermal shock
- Temperature control using core probe
- Improved safety systems







GRILLVAPOR® ELETTRICO / ELECTRIC

Le nostre GRILLVAPOR® elettriche sono considerate **le migliori griglie in commercio** perché, grazie agli accorgimenti strutturali innovativi da noi applicati, offrono all'utilizzatore dei **benefici molto importanti**:

- **Velocità** di preriscaldamento
- **Assenza di fiamme** anche con i prodotti più grassi
- **Pulizia facile e veloce**
- **Uniformità** di temperatura
- **Facilità di utilizzo**
- **Preciso controllo delle temperature**

Il cibo durante la cottura non è mai a contatto diretto con le resistenze elettriche, **garantendo così l'igiene e l'altissima qualità del cibo grigliato**, le rigature sono molto precise sia nel colore sia nel disegno.

Questo tipo di GRILLVAPOR® ha un sistema di **riscaldamento per conduzione** che diffonde **meno calore nell'ambiente di lavoro** rispetto alle griglie tradizionali.

La **manutenzione e la pulizia** delle nostre GRILLVAPOR® elettriche sono **facilmente attuabili**, un esempio è il **piano di cottura ribaltabile** e di facile accesso.

Our electric GRILLVAPOR® units are considered the **best grills on the market**: thanks to the innovative structural features adopted in design, these are products able to offer the user **particularly important benefits**:

- **Fast** preheating
- **No flames** even with fat food
- **Easy and quick cleaning**
- **Uniform** temperature

- **Ease of use**
- **Precise temperature control**

Food never comes into contact with the heating elements during the cooking time, so that **hygiene and high quality of the grilled food** are assured — and appearance too, with grill marks always perfectly coloured and patterned.

This type of GRILLVAPOR® appliance uses a **conduction heating** system that releases **less heat into the work environment** than conventional grills.

The task of **cleaning and servicing** our electric GRILLVAPOR® units is **simplicity itself**, as exemplified by a **hinged cook-top** affording an easy access.





GRILLVAPOR® GAS

Le nostre GRILLVAPOR® a gas sono conosciute per la loro **grande affidabilità** e la facile manutenzione.

Queste GRILLVAPOR® cuociono i cibi per irraggiamento di calore e ogni modulo viene riscaldato da **quattro bruciatori ad alta efficienza** che riscaldano **speciali cupole in acciaio inox**. La cottura degli alimenti avviene senza alcun contatto diretto con la fiamma. I cupolini sono conformati per bruciare al meglio il gas erogato così da consumarne meno ed ottenere un **risparmio per l'utente**.

Le superfici di cottura di tutti i GRILLVAPOR® Gas sono intercambiabili con **4 soluzioni per soddisfare le diverse esigenze**:

- **Grigliato a tondino**, indicato per la maggior parte delle cotture.
- **Grigliato a canaletta**, indicato per la cottura di alimenti con una media percentuale di grasso (es. costine di maiale, agnello e alcuni tagli di manzo con forte presenza di grasso).
- **Grigliato a canaletta sovrapposta**, indicato per la cottura di alimenti grassi (es. pancetta, salsiccia, pollo con pelle, anguilla e carni marinate).
- **Frytop in acciaio inox di grosso spessore**, indicato per alcune cotture specifiche (uova, formaggio, minuterie e colazioni continentali).

Our gas GRILLVAPOR® units are renowned for their **supreme reliability** and easy maintenance.

These GRILLVAPOR® models cook food by heat radiation, using a system in which each module is equipped with **four high efficiency burners** positioned to heat **special stainless steel domes**. The food is never in direct contact with the flame at any stage of the cooking process. The domes are shaped so that the gas can be burned with the aim of using less fuel and securing a **real saving for the end user**.

The cooking surfaces of all Gas GRILLVAPOR® units are available with **4 interchangeable options to satisfy different needs**:

- **Round bar grid**, suitable for cooking most foods.
- **Channelled grid**, suitable for cooking moderately fatty foods (such as pork chops, lamb chops and certain cuts of beef containing a substantial percentage of fat).
- **Double channelled overlapped grid**, suitable for cooking appreciably fatty foods (such as bacon, sausage, skin-on chicken, eel and marinated meats).
- **Thick stainless steel frytop**, suitable for cooking certain specific foods (eggs, cheese, small items and continental breakfasts).





GRILLVAPOR® ELETTRONICO / DIGIT

Arris affianca ai tradizionali comandi manuali il nuovo pratico e intuitivo **pannello elettronico che rende GRILLVAPOR®**, sia nelle versioni elettriche, sia nelle versioni a gas, **più facile da usare, flessibile e sicuro** rispetto alle griglie tradizionali. I nuovi comandi permettono, infatti, il controllo **preciso della potenza erogata**, inoltre le versioni a gas sono dotate di un sistema che mantiene costante la pressione **diminuendo il consumo di gas**. I pulsanti del cruscotto sono protetti contro le accensioni accidentali (ad esempio durante le operazioni di pulizia). Nelle versioni elettroniche la **gestione dell'acqua è automatica**, inoltre prerogativa esclusiva di Arris è la possibilità di seguire la cottura usando la sonda di temperatura.

In addition to the traditional manual controls, Arris offers the new practical and intuitive **electronic control panel**, which makes both electric and gas GRILLVAPOR® units **easier to use, more flexible, and safer** than grills of conventional design. The new electronics, in effect, offer **precision control over power output**, and in the case of gas versions, there is also a system that maintains pressure at a constant level, **reducing the amount of gas consumed**. The buttons of the control panel are protected against accidental use (during the course of cleaning operations, for example). In electronic versions, the **water is controlled automatically**, and there is also the exclusive Arris feature of grilling food with the aid of a core probe to monitor the cooking temperature.







RENDIAMO FACILE IL LAVORO QUOTIDIANO WE LIGHTEN THE DAILY WORKLOAD

Arris presta particolare **attenzione alla gestione della pulizia** delle Grillvapor e Overgrill® per facilitare il lavoro dell'utilizzatore.

La pulizia e manutenzione di tutti i GRILLVAPOR® a gas è facilitata perché tutte le parti del piano cottura si possono sfilare con estrema praticità, incluse le cupoline radianti, per una detersione accurata e semplice.

Inoltre, il frontalino è isolato con materiale a bassissima conducibilità termica ed è di facile pulizia.

Nei modelli GRILLVAPOR® elettrici la pulizia è semplificata in quanto il piano di cottura è ribaltabile e di facile accesso da entrambi i lati grazie alla innovativa soluzione costruttiva.

Data l'alta qualità dei materiali e gli spessori importanti con i quali vengono realizzate, le nostre apparecchiature sono costruite per durare nel tempo.

Per aumentare l'efficienza delle nostre apparecchiature abbiamo introdotto le GRILLVAPOR® con allacciamento idrico che permettono una migliore gestione dell'acqua e un sistema di sicurezza tramite "cassetto con troppo pieno".

I modelli elettronici sono addirittura dotati del pratico sistema di alimentazione automatico dell'acqua per garantirne sempre il giusto livello e, di conseguenza, il vostro miglior risultato di cottura.

Arris takes special **care over the optimization of cleaning methods** for Grillvapor and Overgrill® products, to make life easier for the user.

Cleaning and servicing of all GRILLVAPOR® units that use gas is made easy, since all parts of the cooking top can be removed with extreme ease, including the radiant domes.

Also, the front panel is insulated with material allowing ultra low conduction of heat, and easy to clean.

In the case of GRILLVAPOR® electric models, cleaning is simplified by the adoption of a hinged cook-top and ease of access from both sides, thanks to the innovative constructional design.

Given the high quality of the selected materials and the generous thicknesses adopted, our products are self-evidently built to last.

To increase the efficiency of Arris appliances, GRILLVAPOR® models with a built-in connection to the water utility were introduced enabling better control over water usage and a safety system including a "tray with overflow".

Electronic models are even equipped with a practical automatic water feed system that guarantees the right level at all times, and consequently the best possible results from cooking operations.



SICUREZZA /SAFETY



Nelle versioni elettroniche l'accensione è automatica con sistema di controllo della fiamma. Si evitano così i rischi di spegnimento causati dalla caduta dei succhi trasudati dai cibi durante la cottura. Inoltre i pulsanti del cruscotto sono protetti contro le accensioni accidentali (ad esempio durante le operazioni di pulizia) e la presenza d'acqua nella vaschetta è controllata e mantenuta automaticamente.

Nelle versioni manuali i comandi sul cruscotto sono protetti dagli urti accidentali, l'accensione è piezoelettrica di facile azionamento e sia la fiamma pilota che la termocoppia di sicurezza sono protetti dalla caduta dei grassi.

The electronic models feature automatic ignition and flame control. This means there is no risk of flames being put out by juices dripping from grilled food.

The control panel keys incorporate a function that prevents accidental operation (for example during cleaning). Even the water level in the tray is controlled automatically.

Our manual grills feature controls that are protected against accidental knocks, an easy to operate piezoelectric ignition system, and a pilot flame and safety thermocouple that are protected against falling juices.





OVERGRILL

OVERGRILL è un avanzato sistema di grigliatura che unisce la tecnologia GRILLVAPOR® ad un doppio grigliato elettrico sovrapposto. Overgrill® è inoltre dotato di una **eccezionale distribuzione del calore** sul piano di cottura che permette di cucinare agevolmente anche **cibi congelati** come hamburger, petti di pollo etc. Si adatta allo spessore dei cibi fino a 60 mm in altezza ed è facile e intuitivo grazie al pannello digitale, può anche scaldare solo il **piano inferiore** per essere utilizzato come un GRILLVAPOR® **riducendo** però della **metà il consumo energetico**. Overgrill®, come tutte le apparecchiature Arris elettroniche, può essere dotato di **sonda al cuore** che controlla la temperatura dell'alimento durante tutta la fase di cottura. Inoltre, grazie alla tecnologia GRILLVAPOR® l'umidificazione del piano di cottura permette di trasferire il calore più velocemente sull'alimento, senza seccarlo, **riducendo la perdita di peso (-20%) e mantenendo vivi i colori degli alimenti**.

Vantaggi esclusivi di Overgrill®:

- Memorizza il risultato di cottura e lo rende replicabile da qualsiasi operatore
- Cottura più veloce del 50%
- Diminuzione del costo della manodopera (avviso di fine cottura e sollevamento automatico)
- Assorbimento dello shock termico (risultati eccezionali su hamburger gelo)
- Risparmio energetico a parità di produzione
- Pulizia più veloce, meno costi di manodopera
- Massima produzione e minor ingombro
- Sonda al cuore con avviso acustico per una cottura perfetta

OVERGRILL is an advanced grilling system that combines GRILLVAPOR® technology with two electric grids in clamshell formation. Overgrill® also features an **exceptional distribution of heat** across the cook-top, which means that there are no problems when handling **frozen foods** such as hamburgers, chicken breasts, etc. It adapts to the consistency of foods up to 60 mm thick and is simple and intuitive to use, thanks to the digital control panel; there is also the option of heating only the **bottom grid** and using the appliance as a GRILLVAPOR®, in this case **energy consumption** can be **reduced by half**. Like all electronic Arris appliances, Overgrill® can be equipped with a **core probe** that monitors the temperature of the food throughout the entire cooking process. And thanks to GRILLVAPOR® technology, humidification of the cook-top allows heat to be transferred to the food more quickly, but without drying it, consequently **reducing weight loss (by 20%) and preserving its natural colours**.

Exclusive advantages of Overgrill®:

- Results of cooking memorized so as to allow replication by any operator
- Faster cooking by 50%
- Reduced cost of labour (signal when cooking is complete, and automatic lid lift)
- Absorption of thermal shock (exceptional results cooking frozen hamburgers)
- Lower energy usage per unit of production
- Quicker cleaning, reduced labour costs
- Maximum production with less bulky equipment
- Core probe with audible warning, for perfect cooking results

 OVERGRILL

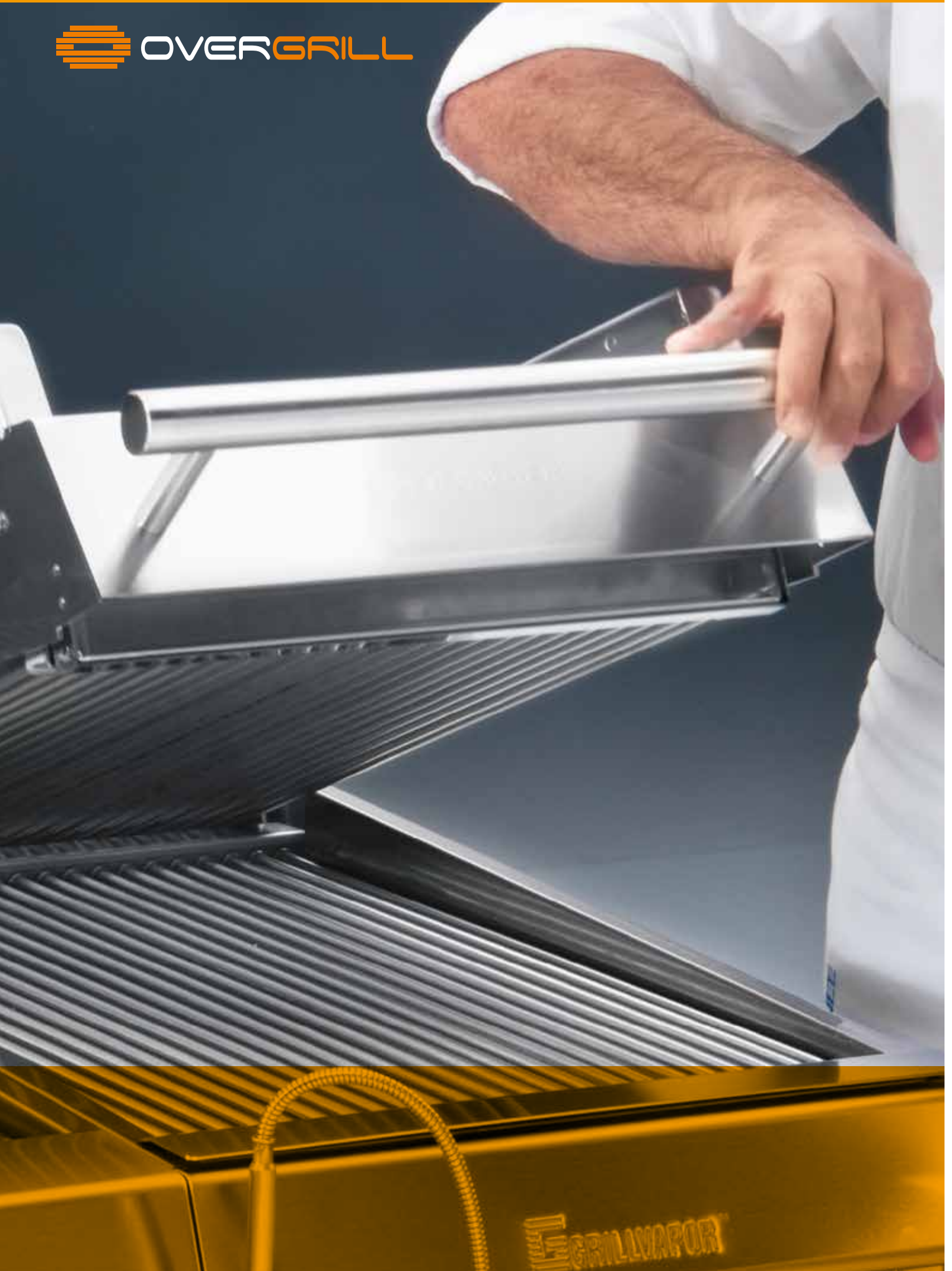

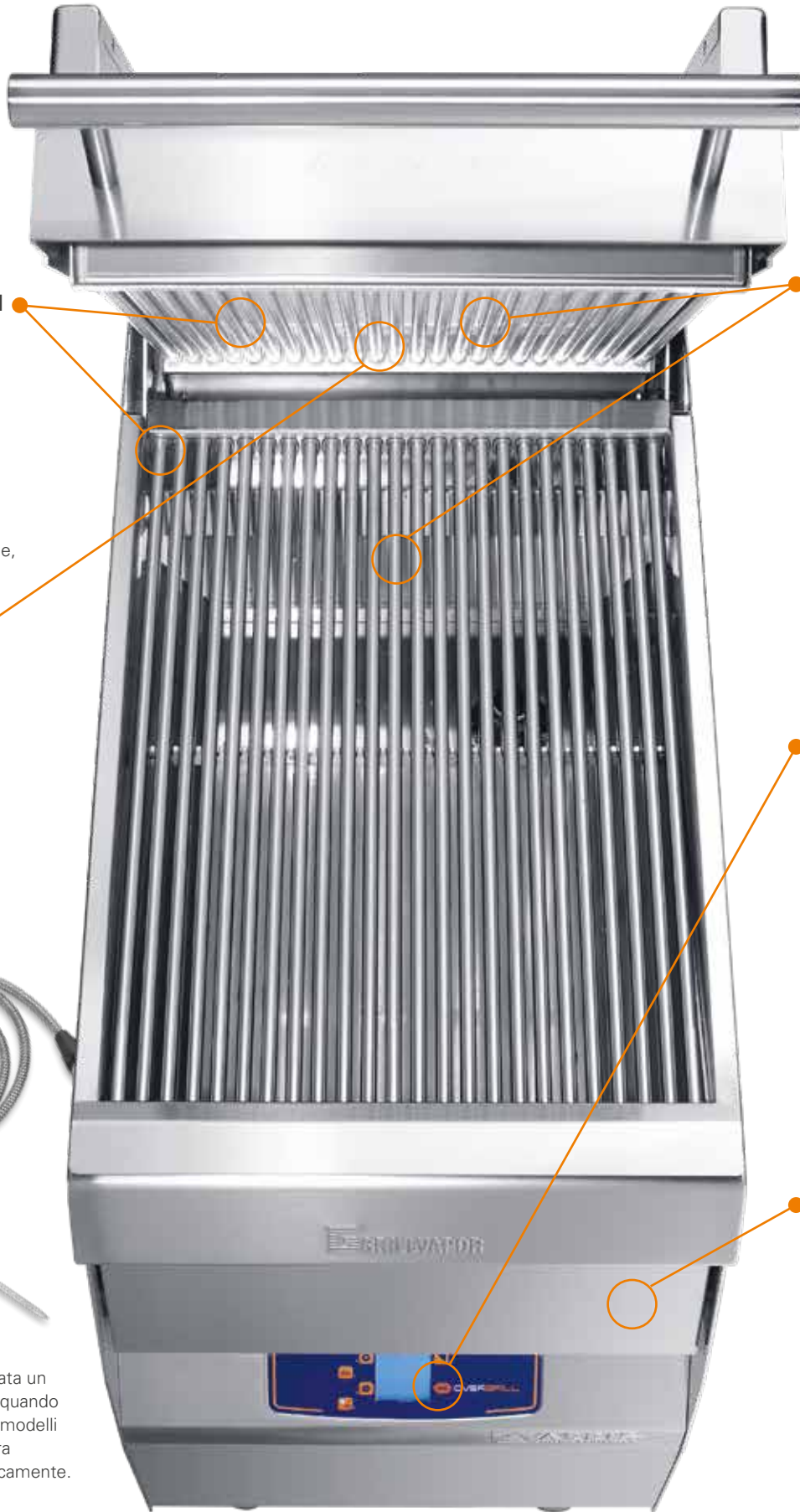

GRIGLIE INDIPENDENTI

Si possono grigliare i cibi contemporaneamente su entrambi i lati, oppure usare solamente il grigliato inferiore come il Grillvapor®.

INDEPENDENT GRILLS

The food can be grilled on both sides at the same time, or the bottom grill can be used on its own, just like a standard Grillvapor®.

SI ADATTA

Il piano superiore si adatta allo spessore dei cibi fino a 60 mm in altezza.

ADAPTABLE

The top grill adapts to food up to 60 mm thick.

SONDA AL CUORE*

Cuoce senza controlli, quando la cottura è terminata un avvisatore acustico avvisa quando la cottura è terminata. Nei modelli AUTOMATIC il piano cottura superiore si apre automaticamente.

CORE TEMPERATURE PROBE*

Cooking without needing to check progress; an audible signal warns when cooking is complete. On the AUTOMATIC models, the top grill opens automatically.

*Optional

**MENO LAVORO
MAGGIORE RESA**

Overgrill griglia i cibi da entrambi i lati eliminando la necessità di girarli e cuoce in metà tempo rispetto ad una griglia tradizionale.

**LESS WORK
MORE SPEED**

Because Overgrill cooks both sides at once, there's no need to turn food over, Overgrill cooks food in half the time needed by conventional grills.

**UN SOLO PANNELLO
ELETTRONICO**

Semplice ed intuitivo per regolare la temperatura delle due griglie in modo indipendente.

**JUST ONE ELECTRONIC
CONTROL PANEL**

The simple and intuitive electronic control panel lets you adjust the temperature of both grills independently.

**ACQUA, UMIDITÀ
E CALORE**

L'acqua contenuta nelle vasche poste sotto il piano di cottura mantiene il cibo più morbido e succoso. All'accensione Overgrill carica l'acqua automaticamente e durante la cottura ne controlla il livello.

WATER

Water, contained in a tray under the grill, keeps your food softer and juicier. Overgrill automatically fills the water tray when you switch on, and constantly monitors water level as you cook.



OVERGRILL® EL TOP

OVERGRILL elettrico da banco in acciaio inox aisi 304 con controllo elettronico programmabile e set 15 di programmi cottura prememorizzati - Distanza tra le griglia impostabile con registro manuale - zone cottura dimensioni mm 380x530 a temperatura regolabile ed indipendente - avviso acustico fine cottura - possibilità di escludere il riscaldamento del piano di cottura superiore

Electric OVERGRILL for worktable made in AISI 304 stainless steel with programmable electronic control panel and set of 15 cooking programs already stored - Distance from upper grids and lower grids set by a manual regulator - independent cooking zones with dimensions 380x530 with independent temperature set - acoustic sound at the end of the cooking section - possibility to exclude the working of the upper cooking surface.



OPTION

Modello / Model	GE 509 EL TOP	GE 509 EL AUTOMATIC TOP
Tipo / Type	Digitale / Digit	Digitale / Digit
Dimensioni ingombro - Overall dimensions	500x900x465	500x900x465
Dimensioni piano cottura / Dimensions of cooking surface	380x530	380x530
Alimentazione - Supply	Elettrica / Electric	Elettrica / Electric
Voltaggio/ Voltage	400V3N - 11,6 - 50/60 Hz 230V3 - 20,10 - 50/60 Hz	400V3N - 11,6 - 50/60 Hz 230V3 - 20,10 - 50/60 Hz
Potenza Elettrica - Electric Power kw	8	8
Costruzione / Building	Acc. Inox AISI 304 SC Brite Stainless steel AISI 304 Scoth Brite	Acc. Inox AISI 304 SC Brite Stainless steel AISI 304 Scoth Brite
Grigliato cottura / Grilled cooking	Tondino / Round	Tondino / Round
Regolazione piani cottura / Adjusting device	Si	Si
Allaccio idrico / Water connection	-	-
Carico acqua / Water filling	Manuale / Manual	Manuale / Manual
Sonda al cuore / Core probe	Optional	Optional
Apertura aut. fine cottura / Automatic opening at the end of cooking	-	Si
Volume imballo mc / Packing volume mc	0,46	0,46
Peso lordo Kg / Gross Weight Kg	96	104

ACCESSORI / ACCESSORIES

KS01	Kit sonda al cuore / Kit core probe
SSPI	Spazzola / Brush

KS01

SSPI
CARATTERISTICHE
GE 509EL: carico acqua manuale - cassetto estraibile frontalmente.
GE 519EL: carico acqua automatico - predisposta per allacciamento idrico.
Vasca raccolta grassi estraibile dal piano cottura.
Top: modello da banco.
Automatic: apertura automatica piano cottura superiore a fine cottura.
CARATERISTICS
GE 509EL: manual fill and download of water - remouvable drawer from front.
GE 519EL: automatic fill and download of water - water supply - tray collector of fats.
Remouvable from the cooking zone.
TOP: table to model.
Automatic: automatic opening of the upper cooking surface.

GE 519 EL TOP	GE 519 EL AUTOMATIC TOP
Digitale / Digit	Digitale / Digit
500x900x465	500x900x465
380x530	380x530
Elettrica / Electric	Elettrica / Electric
400V3N -11,6 - 50/60 Hz 230V3 - 20,10 - 50/60 Hz	400V3N -11,6 - 50/60 Hz 230V3 - 20,10 - 50/60 Hz
8	8
Acc. Inox AISI 304 SC Brite Stainless steel AISI 304 Scoth Brite	Acc. Inox AISI 304 SC Brite Stainless steel AISI 304 Scoth Brite
Tondino / Round	Tondino / Round
Si	Si
Si	Si
Automatico / Automatic	Automatico / Automatic
Optional	Optional
-	Si
0,46	0,46
96	104

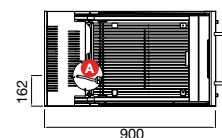
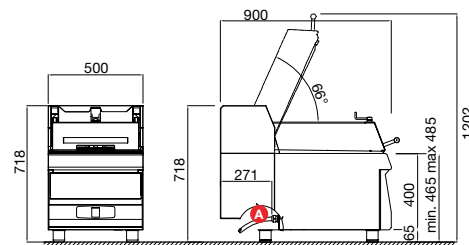
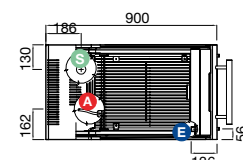
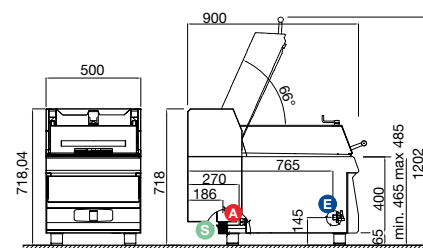
GE 509 EL TOP / GE 509 EL TOP AUTOMATIC

GE 519 EL TOP / GE 519 EL TOP AUTOMATIC

OVERGRILL® EL MONOBLOCCO

OVERGRILL elettrico su mobile in acciaio inox aisi 304 con controllo elettronico programmabile e set 15 di programmi cottura prememorizzati - Distanza tra le griglia impostabile con registro manuale - zone cottura dimensioni mm 380x530 a temperatura regolabile ed indipendente - avviso acustico fine cottura - possibilità di escludere il riscaldamento del piano di cottura superiore

Electric supplied OVERGRILL made in AISI 304 stainless steel with programmable electronic control panel and set of 15 cooking programs already stored - Distance from upper grids and lower grids set by a manual regulator - independent cooking zones with dimensions 380x530 with independent temperature set - acoustic sound at the end of the cooking section - possibility to exclude the working of the upper cooking surface.



Modello / Model	GE 509 EL	GE 509 EL AUTOMATIC
Tipo / Type	Digitale / Digit	Digitale / Digit
Dimensioni ingombro - Overall dimensions	500x900x900	500x900x900
Dimensioni piano cottura / Dimensions of cooking surface	380x530	380x530
Alimentazione - Supply	Elettrica / Electric	Elettrica / Electric
Voltaggio/ Voltage	400V3N - 11,6 - 50/60 Hz 230V3 - 20,1 - 50/60 Hz	400V3N - 11,6 - 50/60 Hz 230V3 - 20,1 - 50/60 Hz
Potenza Elettrica - Electric Power kw	8	8
Costruzione / Building	Acc. Inox AISI 304 SC Brite Stainless steel AISI 304 Scoth Brite	Acc. Inox AISI 304 SC Brite Stainless steel AISI 304 Scoth Brite
Grigliato cottura - Grilled cooking	Tondino / Round	Tondino / Round
Regolazione piani cottura / Adjusting device	Sì	Sì
Allaccio idrico / Water connection	-	-
Carico acqua / Water filling	Manuale / Manual	Manuale / Manual
Sonda al cuore / Core probe	Optional	Optional
Apertura aut. fine cottura / Automatic opening at the end of cooking	-	Sì
Volume imballo mc / Packing volume mc	0,76	0,76
Peso lordo Kg / Gross Weight Kg	111	116

ACCESSORI / ACCESSORIES

KS01	Kit sonda al cuore / Kit core probe
RG 200/R	Kit ruote girevoli / Kit wheels
SSPI	Spazzola / Brush

KS01

RG 200/R

SSPI
CARATTERISTICHE
GE 509EL: carico acqua manuale - cassetto estraibile frontalmente.
GE 519EL: carico acqua automatico - predisposta per allacciamento idrico.
Vasca raccolta grassi estraibile dal piano cottura.
Top: modello da banco.
Automatic: apertura automatica piano cottura superiore a fine cottura.
I modelli provvisti con mobile vengono forniti con i piedini, per le ruote aggiungere il costo cod. RG200/R
CARATERISTICS
GE 509EL: manual fill and download of water - remouvable drawer from front.
GE 519EL: automatic fill and download of water - water supply - tray collector of fats.
Removable from the cooking zone.
TOP: table to model.
Automatic: automatic opening of the upper cooking surface.
The stand models will be supplied with their feet, if the kit wheels is requested, add the cost of code RG200/R.

GE 519 EL	GE 519 EL AUTOMATIC
Digitale / Digit	Digitale / Digit
500x900x900	500x900x900
380x530	380x530
Elettrica / Electric	Elettrica / Electric
400V3N - 11,6 - 50/60 Hz 230V3 - 20,1 - 50/60 Hz	400V3N - 11,6 - 50/60 Hz 230V3 - 20,1 - 50/60 Hz
8	8
Acc. Inox AISI 304 SC Brite Stainless steel AISI 304 Scoth Brite	Acc. Inox AISI 304 SC Brite Stainless steel AISI 304 Scoth Brite
Tondino / Round	Tondino / Round
Si	Si
Si	Si
Automatico / Automatic	Automatico / Automatic
Optional	Optional
-	SI
0,76	0,76
111	111

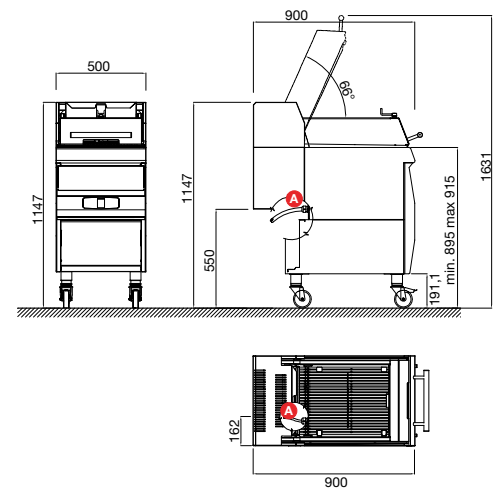
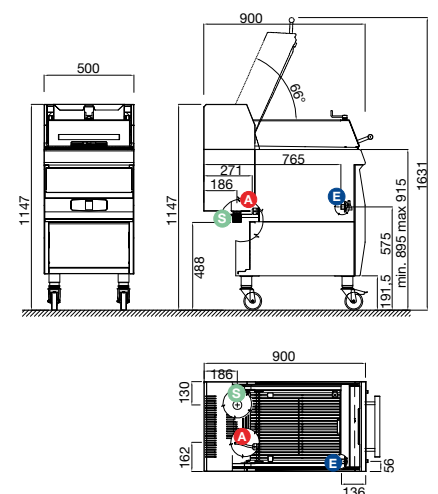
GE 509 EL / GE 509 EL AUTOMATIC

GE 519 EL / GE 519 EL AUTOMATIC

GRILLVAPOR® DIGIT

Grazie ai nuovi comandi elettronici, l'accensione e il controllo della fiamma sono automatici **eliminando così tutte le problematiche** tipiche dei sistemi con fiamma pilota e l'usura del piezoelettrico. Inoltre, abbiamo introdotto dei **sistemi di sicurezza** che salvaguardano l'operatore e **prevengono eventuali errori**.

Vantaggi

- Precisione nell'erogazione della temperatura
- Gestione precisa delle basse temperature
- Controllo dell'immissione dell'acqua automatico
- Minore consumo energetico
- Sistemi di sicurezza integrati
- Possibilità di connettere la sonda di temperatura
- Accensione elettronica senza usura

With the new electronic controls, ignition and regulation of the flame are automatic, thereby **eliminating** all the **problems** of unpredictability and wear typically affecting systems that use pilot flames or piezo igniters. In addition, we have introduced **safety systems** designed to safeguard the operator and **prevent possible errors**.

Advantages:

- Precision temperature delivery
- Accurate control of low temperatures
- Water usage controlled automatically
- Lower energy consumption
- Built-in safety systems
- Option of connecting core probe
- Wear-free electronic ignition







GRILLVAPOR® DIGIT EL TOP

Grillvapor Elettrico da banco realizzato in acciaio inox AISI304 - controllo elettronico - Zona cottura a temperatura regolabile - cassetto con vasca raccolta acqua a riempimento manuale - Piano cottura ribaltabile.

Stainless steel AISI304 Scotch Brite electric Top Grillvapor for worktable - cooking surface with adjustable temperature - drawer equipped with manually - loaded water collector Tip-up cook-top.



OPTION

Modello / Model	GE 407 EL TOP *GE 407 EL/M TOP	GE 807 EL TOP	GE 1207 EL TOP
Tipo / Type	Digitale / Digital	Digitale / Digital	Digitale / Digital
Dimensioni ingombro Overall dimensions	420x700x440	800x700x440	1195x700x440
Dimensioni piano cottura Dimensions of cooking surface	390x530	760x530	1155x530
Alimentazione / Supply	Elettrica / Electric	Elettrica / Electric	Elettrica / Electric
Voltaggio/ Voltage	400V3N - 7,5A - 50/60Hz 230 V3 - 13A - 50/60Hz 230V - 22,6A - 50/60Hz*	4003VN - 15A - 50/60Hz 230V3 - 26,2A - 50/60Hz	400V3N - 22,6A - 50/60Hz 230V3 - 39,3A - 50/60Hz
Potenza Elettrica - Electric Power kw	5,21	10,42	15,63
Potenza Gas - Gas Power kw	-	-	-
Consumo metano - mc/h-GPL Kg/h Consumption methane - mc/nh-LPG Kg/h	-	-	-
Costruzione / Building	Acc. Inox AISI 304 SC Brite Stainless steel AISI 304 Scotch Brite	Acc. Inox AISI 304 SC Brite Stainless steel AISI 304 Scotch Brite	Acc. Inox AISI 304 SC Brite Stainless steel AISI 304 Scotch Brite
Grigliato cottura / Grilled cooking	Tondino / Round	Tondino / Round	Tondino / Round
Regolazione piani cottura Adjusting device	-	-	-
Allaccio idrico / Water connection	-	-	-
Carico acqua Water filling	Manuale / Manual	Manuale / Manual	Manuale / Manual
Sonda al cuore / Core probe	Optional	Optional	Optional
Volume imballo mc Packing volume mc	0,26	0,47	0,69
Peso lordo Kg / Gross Weight Kg	50	83	117

* Per voltaggio 230V Monofase specificare all'ordine GE407EL/M Top solo per questo modello./ * Voltage 230V single phase must be specified as GE407EL/M Top at the moment of the order.

ACCESSORI / ACCESSORIES

KS01	Kit sonda al cuore / <i>Kit core probe</i>
SSPI	Spazzola / <i>Brush</i>
FTI70E	Fry top serie 700 elettriche / <i>700 Series Electric Fry top</i>
B70/90	Supporto su gambe 700/900 / <i>Feet to support 700/900</i>
FTI90E	Fry top serie 900 elettriche / <i>900 Series Electric Fry top</i>
RAS-EL	Raschietto per piano cottura elettrico / <i>Electric scraper</i>
RG 200/R	Kit ruote girevoli / <i>Kit wheels</i>
1.910	Paraschizzi completo 407-417 / <i>Complete splashboard frame 407-417</i>
1.911	Paraschizzi completo 409-419 / <i>Complete splashboard frame 409-419</i>
1.912	Paraschizzi completo 807-817 / <i>Complete splashboard frame 807-817</i>
1.913	Paraschizzi completo 809-819 / <i>Complete splashboard frame 809-819</i>
1.914	Paraschizzi completo 1207-1217 / <i>Complete splashboard frame 1207-1217</i>
1.915	Paraschizzi completo 1209-1219 / <i>Complete splashboard frame 1209-1219</i>
01.236	Coppia supporto ripiani / <i>Couple of shelf supports</i>
01.237	Ripiano forato da applicare su cod. 01.236 / <i>Drilled shelf to be put on item's code 01.236</i>
01.250	Ripiano supporto vaschetta GN1/3 da applicare su cod. 01.236. (vaschetta esclusa) <i>Support bowl GN1/3 shelf to be put on item's code 01.236 (bowl is excluded)</i>
CL47	Cloche per singolo modulo serie 700 / <i>Cloche single cooking surface 700 series</i>
CL49	Cloche per singolo modulo serie 900 / <i>Cloche single cooking surface 900 series</i>
C070	Copertura in acciaio inox per pulizia modulo da 700 <i>Top cover for cleaning in stainless steel suitable for serie 700</i>
C090	Copertura in acciaio inox per pulizia modulo da 900 <i>Top cover for cleaning in stainless steel suitable for serie 900</i>

FTI70E - FTI90E
Dim. 370x474
Dim. 370x674

KS01
B70/90

RAS-EL
SSPI
RG 200/R
Solo per MR/MC
Only for MR/MC

CL47 / CL49
01.237
01.250
Vaschetta non inclusa
Bowl not Included

01.236
1.910 / 1.911
1.912 / 1.913
1.914 / 1.915
C070
C090
GE 409 EL TOP
GE 809 EL TOP

Digitale / Digital	Digitale / Digital
420x900x440	800x900x440
390x730	760x730
Elettrica / Electric	Elettrica / Electric
400V3N - 11,3A - 50/60Hz 230V3 - 19,6A - 50/60Hz	400V3N - 22,6A - 50/60Hz 230V3 - 32,3A - 50/60Hz
7,81	15,62
-	-
-	-
Acc. Inox AISI 304 SC Brite Stainless steel AISI 304 Scoth Brite	Acc. Inox AISI 304 SC Brite Stainless steel AISI 304 Scoth Brite
Tondino / Round	Tondino / Round
-	-
-	-
Manuale / Manual	Manuale / Manual
Optional	Optional
0,33	0,60
57	98

MOBILI PER GRILLVAPOR EL/GAS/TOP
CABINET FOR GRILLVAPOR EL/GAS/TOP

Mobile Aperto <i>Open cabinet</i>	Dimensioni LxPxH <i>Dimensions</i>	
MR47 (407)	420x555x450	€ 370,00
MR87 (807)	800x555x450	€ 440,00
MR127 (1207)	1195x555x450	€ 490,00
MR49 (409)	420x755x450	€ 430,00
MR89 (809)	800x755x450	€ 480,00
MR129 (1209)	1195x755x450	€ 530,00



Mobile Chiuso <i>Closed cabinet</i>	Dimensioni LxPxH <i>Dimensions</i>	
MC47 (407)	420x555x450	€ 370,00
MC87 (807)	800x555x450	€ 440,00
MC127 (1207)	1195x555x450	€ 490,00
MC49 (409)	420x755x450	€ 430,00
MC89 (809)	800x755x450	€ 480,00
MC129 (1209)	1195x755x450	€ 530,00

GRILLVAPOR® DIGIT EL MONOBLOCCO

Grillvapor elettrico su mobile realizzato in acciaio inox AISI 304 - controllo elettronico - zona cottura a temperatura regolabile - cassetto a guide scorrevoli con vasca raccolta acqua - controllo livello e carico acqua automatico - allacciamento idrico.

AISI 304 stainless steel electric-supplied Grillvapor built-in on the furniture - electronic control - cooking surface with adjustable temperature - drawer with slide-ways equipped with water collector - level control and automatic water load - water connection.



Modello / Model	GE 417 EL *GE 417 EL/M TOP	GE 817 EL	GE 1217 EL
Tipo / Type	Digitale / Digital	Digitale / Digital	Digitale / Digital
Dimensioni ingombro Overall dimensions	420x700x850	800x700x850	1195x700x850
Dimensioni piano cottura Dimensions of cooking surface	390x530	760x530	1155x530
Alimentazione / Supply	Elettrica / Electric	Elettrica / Electric	Elettrica / Electric
Voltaggio/ Voltage	400V3N - 7,5A - 50/60Hz 230 V3 - 13A - 50/60Hz 230V - 22,6A - 50/60Hz*	400V3N - 15A - 50/60Hz 230V3 - 26,2A - 50/60Hz	400V3N - 22,6A - 50/60Hz 230V3 - 39,3A - 50/60Hz
Potenza Elettrica - Electric Power kw	5,21	10,42	15,63
Potenza Gas - Gas Power kw	-	-	-
Consumo metano - mc/h-GPL Kg/h Consumption methane - mc/nh-LPG Kg/h	-	-	-
Costruzione / Building	Acc. Inox AISI 304 SC Brite Stainless steel AISI 304 Scoth Brite	Acc. Inox AISI 304 SC Brite Stainless steel AISI 304 Scoth Brite	Acc. Inox AISI 304 SC Brite Stainless steel AISI 304 Scoth Brite
Grigliato cottura / Grilled cooking	Tondino / Round	Tondino / Round	Tondino / Round
Regolazione piani cottura Adjusting device	-	-	-
Allaccio idrico / Water connection	Si	Si	Si
Carico acqua Water filling	Automatico / Automatic	Automatico / Automatic	Automatico / Automatic
Sonda al cuore / Core probe	Optional	Optional	Optional
Volume imballo mc Packing volume mc	0,35	0,61	0,90
Peso lordo Kg / Gross Weight Kg	61	98	132

* Per voltaggio 230V Monofase specificare all'ordine GE417EL/M solo per questo modello./ * Voltage 230V single phase must be specified as GE417EL/M at the moment of the order.

ACCESSORI / ACCESSORIES

KS01	Kit sonda al cuore / <i>Kit core probe</i>
FT170E	Fry top serie 700 elettriche / <i>700 serie Electric Fry top</i>
FT190E	Fry top serie 900 elettriche / <i>900 Series Electric Fry top</i>
SSPI	Spazzola / <i>Brush</i>
RAS-EL	Raschietto per piano cottura elettrico / <i>Electric scraper</i>
RG 200/R	Kit ruote girevoli / <i>Kit wheels</i>
1.910	Paraschizzi completo 407-417 / <i>Complete splashboard frame 407-417</i>
1.911	Paraschizzi completo 409-419 / <i>Complete splashboard frame 409-419</i>
1.912	Paraschizzi completo 807-817 / <i>Complete splashboard frame 807-817</i>
1.913	Paraschizzi completo 809-819 / <i>Complete splashboard frame 809-819</i>
1.914	Paraschizzi completo 1207-1217 / <i>Complete splashboard frame 1207-1217</i>
1.915	Paraschizzi completo 1209-1219 / <i>Complete splashboard frame 1209-1219</i>
01.236	Coppia supporto ripiani / <i>Couple of shelf supports</i>
01.237	Ripiano forato da applicare su cod. 01.236 / <i>Drilled shelf to be put on item's code 01.236</i>
01.250	Ripiano supporto vaschette GN1/3 da applicare su cod. 01.236. (vaschetta esclusa) / <i>Support bowl GN1/3 shelf to be put on item's code 01.236 (bowl is excluded)</i>
CL47	Cloche per singolo modulo serie 700 / <i>Cloche single cooking surface 700 series</i>
CL49	Cloche per singolo modulo serie 900 / <i>Cloche single cooking surface 900 series</i>
C070	Copertura in acciaio inox per pulizia modulo da 700 / <i>Top cover for cleaning in stainless steel suitable for serie 700</i>
C090	Copertura in acciaio inox per pulizia modulo da 900 / <i>Top cover for cleaning in stainless steel suitable for serie 900</i>

FT170E - FT190E
 Dim. 370x474
 Dim. 370x674

KS01

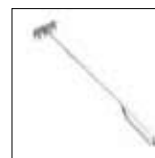
RG 200/R

RAS-EL

SSPI

CL47 / CL49

01.237

01.250
 Vaschetta non inclusa
 Bowl not included

01.236

1.910 / 1.911
1.912 / 1.913
1.914 / 1.915

C070
C090

GE 419 EL	GE 819 EL
Digitale / Digital	Digitale / Digital
420x900x850	800x900x850
390x730	760x730
Elettrica / Electric	Elettrica / Electric
400V3N - 11,3A - 50/60Hz 230V3 - 19,6A - 50/60Hz	400V3N - 22,5A - 50/60Hz 230V3 - 32,2A - 50/60Hz
7,81	15,62
-	-
-	-
Acc. Inox AISI 304 SC Brite Stainless steel AISI 304 Scoth Brite	Acc. Inox AISI 304 SC Brite Stainless steel AISI 304 Scoth Brite
Tondino / Round	Tondino / Round
-	-
Si	Si
Automatico / Automatic	Automatico / Automatic
Optional	Optional
0,44	0,78
73	117

OPTIONAL KS01

GRILLVAPOR® DIGIT GAS MONOBLOCCO



Grillvapor a gas su mobile realizzato in acciaio inox AISI 304 - controllo elettronico - zone cottura a temperatura regolabile - grigliati cottura a tondino - accensioni e controlli fiamma bruciatore elettronici - cassetto a guide scorrevoli con vasca raccolta acqua - controllo livello e carico acqua automatico - allacciamento idrico - alimentazione a gas metano o GPL con valvola modulante completa di sensore di pressione.

AISI 304 stainless steel gas-supplied Grillvapor built-in on the furniture - electronic control - cooking surfaces with adjustable temperature - bar-type cooking gridirons - ignitions and electronic burner's flame controls - drawer with slide-ways equipped with water collector - level control and automatic water load - water connection - LPG or natural gas supply with modular valve equipped with pressure sensor.



Modello / Model	GE 417	GE 817	GE 1217
Tipo / Type	Digitale / Digital	Digitale / Digital	Digitale / Digital
Dimensioni ingombro <i>Overall dimensions</i>	420x700x850	800x700x850	1195x700x850
Dimensioni piano cottura <i>Dimensions of cooking surface</i>	390x470	760x470	115x470
Alimentazione / Supply	Gas (3/4")	Gas (3/4")	Gas (3/4")
Voltaggio/ Voltage	230V - 50/60Hz	230V - 50/60Hz	230V - 50/60Hz
Potenza Elettrica - Electric Power kw	0,02	0,04	0,06
Potenza Gas - Gas Power kw	10,5	21	31,5
Consumo metano - mc/h-GPL Kg/h <i>Consumption methane - mc/nh-LPG Kg/h</i>	1,1 / 0,82	2,2 / 1,64	3,3 / 2,46
Costruzione / Building	Acc. Inox AISI 304 SC Brite Stainless steel AISI 304 Scoth Brite	Acc. Inox AISI 304 SC Brite Stainless steel AISI 304 Scoth Brite	Acc. Inox AISI 304 SC Brite Stainless steel AISI 304 Scoth Brite
Grigliato cottura / Grilled cooking	Tondino / Round	Tondino / Round	Tondino / Round
Regolazione piani cottura <i>Adjusting device</i>	Optional (1xREG70)	Optional (2xREG70)	Optional (3xREG70)
Allaccio idrico / Water connection	Si	Si	Si
Carico acqua <i>Water filling</i>	Automatico / Automatic	Automatico / Automatic	Automatico / Automatic
Sonda al cuore / Core probe	Optional	Optional	Optional
Volume imballo mc <i>Packing volume mc</i>	0,35	0,61	0,90
Peso lordo Kg / Gross Weight Kg	61	98	132

KS01	Kit sonda al cuore / Kit core probe
FTI70	Fry-top serie 700 gas / 700 Series Gas Fry top
GT70-1*	Grigliato a tondino 1/2 modulo serie 700 / Half round shaped cooking gridiron 700 series
GC70-1*	Grigliato a "V" 1/2 modulo serie 700 / Half channeled shaped cooking gridiron 700 series
GDC70-1*	Grigliato a doppia "V" sovrapposta 1/2 modulo serie 700 Half double channeled overlapping shaped cooking gridiron 700 series
FTI90	Fry top serie 900 gas / 900 Series Gas Fry top
GT90-1*	Grigliato a tondino 1/2 modulo serie 900 / Half round shaped cooking gridiron 900 series
GC90-1*	Grigliato a "V" 1/2 modulo serie 900 / Half channeled shaped cooking gridiron 900 series
GDC90-1*	Grigliato a doppia "V" sovrapposta 1/2 modulo serie 900 Half double channeled overlapping shaped cooking gridiron 900 series
SSPI	Spazzola / Brush
RAS-GAS	Raschietto per piano gas / Gas scraper
RG 200/R	Kit ruote girevoli / Kit wheels
1.910	Paraschizzi completo 407-417 / Complete splashboard frame 407-417
1.911	Paraschizzi completo 409-419 / Complete splashboard frame 409-419
1.912	Paraschizzi completo 807-817 / Complete splashboard frame 807-817
1.913	Paraschizzi completo 809-819 / Complete splashboard frame 809-819
1.914	Paraschizzi completo 1207-1217 / Complete splashboard frame 1207-1217
1.915	Paraschizzi completo 1209-1219 / Complete splashboard frame 1209-1219
01.236	Coppia supporto ripiani / Couple of shelf supports
01.237	Ripiano forato da applicare su cod. 01.236 / Drilled shelf to be put on item's code 01.236
01.250	Ripiano supporto vaschetta GN1/3 da applicare su cod. 01.236. (vaschetta esclusa) Support bowl GN1/3 shelf to be put on item's code 01.236 (bowl is excluded)
CL47	Cloche per singolo modulo serie 700 / Cloche single cooking surface 700 series
CL49	Cloche per singolo modulo serie 900 / Cloche single cooking surface 900 series



* Per completare il modulo cottura utilizzare 2 pz. / * 2 pieces to cover the all cooking surface



GE 419	GE 819	GE 1219
Digitale / Digital	Digitale / Digital	Digitale / Digital
420x900x850	800x900x850	1195x900x850
390x670	760x670	1155x670
Gas (3/4")	Gas (3/4")	Gas (3/4")
230V -50/60Hz	230V - 50/60Hz	230V -50/60Hz
0,02	0,04	0,06
13	26	39
1,37 / 1,02	2,75 / 2,03	4,13 / 3,05
Acc. Inox AISI 304 SC Brite Stainless steel AISI 304 Scoth Brite	Acc. Inox AISI 304 SC Brite Stainless steel AISI 304 Scoth Brite	Acc. Inox AISI 304 SC Brite Stainless steel AISI 304 Scoth Brite
Tondino / Round	Tondino / Round	Tondino / Round
Optional (1xREG90)	Optional (2xREG90)	Optional (3xREG90)
Si	Si	Si
Automatico / Automatic	Automatico / Automatic	Automatico / Automatic
Optional	Optional	Optional
0,44	0,78	1,15
73	113	153



OPTIONAL KS01

FRY TOP GREEN ENERGY

La particolarità del Fry-top Green Energy Arris è dovuta all'inerzia termica che viene trasmessa dalle resistenze elettriche di bassa potenza al piano di cottura. La nostra tecnologia Arris ci permette di utilizzare una potenza inferiore del 25%-30% rispetto ad una apparecchiature della stessa dimensione presente sul mercato. Grazie alla particolare composizione dei materiali e delle caratteristiche termiche si può raggiungere un RISPARMIO ENERGETICO fino ad un 50%, escludendo particolari tempi di recupero della temperatura.

Vantaggi esclusivi del FRY-TOP GREEN ENERGY

- Rispetto dell'ambiente
- Risparmio energetico a parità di produzione
- Uniformità della temperatura sul piano di cottura.
- Assorbimento dello shock termico.
- Tutela dell'operatore per minor irraggiamento termico nell'ambiente di lavoro.
- Sonda al cuore con avviso acustico per una cottura perfetta.
- Facile pulizia per un risparmio del costo della manodopera
- Gestione precisa della temperatura.
- Superficie di cottura che favorisce una naturale anti-aderenza di qualsiasi tipo di prodotto

The peculiarity of Arris Fry-top Green Energy is due to thermal inertia, which is conveyed to the cooking surface by the heating elements of low power. Our technology Arris allows us to use a lower power i.e. 25%-30% comparing with an appliance with the same dimensions in the market. Thanks to the particular compositions of the materials and to the thermal characteristics, an ENERGY SAVING up to 50% can be reached, particular temperature recovery times to be excluded.

Exclusive benefits of FRY-TOP GREEN ENERGY

- Respect for the environment.
- Energy saving for the same production.
- Uniformity of temperature on the cooking surface.
- Absorption of thermal shock.
- Protection for the operator. Low thermal irradiation on the work environment.
- Core probe temperature device with acoustic sound for a perfect result.
- Easy cleaning to save money in labor cost.
- Precise management of the temperature.
- Cooking surface that promotes a natural anti-adherence of any type of product



FRY TOP GREEN ENERGY DIGIT EL TOP

Fry top elettrico a controllo digitale da banco o su mobile realizzato in acciaio inox Aisi 304. Telaio supporto piastra da 3 mm e piastra di cottura da 25 mm di spessore. Interamente saldata e ribassata di 30 mm con superficie di cottura liscia leggermente inclinata in acciaio inox. Alzatina paraspruzzi removibile inclusa. Tutti i modelli sono previsti di termostato di sicurezza. La temperatura di esercizio è regolabile fino a 280°C. Foro di scarico rettangolare e cassetto per la raccolta grassi di grande capacità (da 2 a 10 lt) estraibile per la pulizia posizionato su guide scorrevoli.

Electric digit Fry top table top or with stand made in stainless steel Aisi 304. Structure of support flat cooking surface thickness 3 mm and flat cooking surface thickness 25 mm. Entirely welded and lowered by 30 mm with slightly inclined flat cooking surface in stainless steel. Removable splashboard frame included. All models have the safety thermostat. The cooking temperature can be regulated up to 280°C. Rectangular drain hole and extractable drawer for fat collection on sliding guides, great capacity (from 2 to 10 lt).



OPTION

Modello / Model	FT 407 EL TOP FL 407 EL/M TOP	FT 807 EL TOP
Tipo / Type	Digitale / Digital	Digitale / Digital
Dimensioni ingombro Overall dimensions	420x700x400	800x700x400
Dimensioni piano cottura Dimensions of cooking surface	340x510	720x510
Alimentazione / Supply	Elettrica / Electric	Elettrica / Electric
Voltaggio / Voltage	400V3N - 50/60Hz 230 V3 - 50/60Hz 230V - 50/60Hz*	4003VN - 50/60Hz 230V3 - 50/60Hz
Potenza Elettrica - Electric Power kw	3,1	6,9
Potenza Gas - Gas Power kw	-	-
Consumo metano - mc/h-GPL Kg/h Consumption methane - mc/nh-LPG Kg/h	-	-
Costruzione / Building	Acciaio inox / Stainless steel	Acciaio inox / Stainless steel
Piano cottura / Grilled cooking	Liscio	Liscio
Regolazione piani cottura Adjusting device	-	-
Allaccio idrico / Water connection	-	-
Carico acqua Water filling	-	-
Sonda al cuore / Core probe	Optional	Optional
Volume imballo mc Packing volume mc	0,26	0,47
Peso lordo Kg / Gross Weight Kg	50	120

* Per voltaggio 230V Monofase specificare all'ordine GE407EL/M Top solo per questo modello.

* Voltage 230V single phase must be specified as GE407EL/M Top at the moment of the order.

ACCESSORI / ACCESSORIES

KS01	Kit sonda al cuore / <i>Kit core probe</i>
RAS-FT	Raschietto per piano Fry Top liscio / <i>Fry Top scraper</i>
RG 200/R	Kit ruote girevoli / <i>Kit wheels</i>
01.236	Coppia supporto ripiani / <i>Couple of shelf supports</i>
01.237	Ripiano forato da applicare su cod. 01.236 <i>Drilled shelf to be put on item's code 01.236</i>
01.250	Ripiano supporto vaschette GN1/3 da applicare su cod. 01.236 (vaschetta esclusa) / <i>Support bowl GN1/3 shelf to be put on item's code 01.236 (bowls are excluded)</i>
CL47	Cloche per singolo modulo serie 700 / <i>Cloche single cooking surface 700 series</i>
CL49	Cloche per singolo modulo serie 900 / <i>Cloche single cooking surface 900 series</i>

KS01

RAS-FT

RG 200/R
Solo per MF
Only for MF

CL47 / CL49

01.237

01.250
Vaschetta non inclusa
Bowl not included

01.236

FT 409 EL TOP	FT 809 EL TOP
Digitale / Digital	Digitale / Digital
420x900x400	800x900x400
340x710	720x710
Elettrica / Electric	Elettrica / Electric
400V3N - 50/60Hz 230V3 - 50/60Hz	400V3N - 50/60Hz 230V3 - 50/60Hz
4,6	10,5
-	-
-	-
Acciaio inox / Stainless steel	Acciaio inox / Stainless steel
Liscio	Liscio
-	-
-	-
-	-
Optional	Optional
0,33	0,60
70	140

**MOBILI PER FRY TOP EL / TOP
CABINET FOR FRY TOP EL / TOP**

Mobile Aperto <i>Open cabinet</i>	Dimensioni LxPxH <i>Dimensions</i>
MF47 (407)	420x555x450
MF87 (807)	800x555x450
MF49 (409)	420x755x450
MF89 (809)	800x755x450



GRILLVAPOR® POWER

LINEA POWER è la linea di GRILLVAPOR® Arris che unisce le performances e i benefici di cottura della tecnologia GRILLVAPOR® al raggiungimento di **alte temperature** indispensabili per le carni di grosso spessore.

La linea GRILLVAPOR® POWER è indicata per cotture rapide ad alte temperature, tipo high grilling, in quanto raggiunge la temperatura di oltre 400°C **uniformemente diffusa su tutto piano di cottura** grazie all'utilizzo di **bruciatori ad alta efficienza** che cucinano i cibi per irraggiamento. Inoltre, le griglie sono dotate di un dispositivo che modifica l'altezza del grigliato per una rapida regolazione del calore trasmesso al cibo. GRILLVAPOR® linea power è particolarmente adatta per: fiorentine, carne di cavallo, carne di bisonte, rump steak, flank steak, T-bone, dry aged beef, e tutte le tecniche di high grilling.

The POWER LINE is the range of Arris GRILLVAPOR® units that combines top performance and the benefits of GRILLVAPOR® technology with the **high temperatures** needed for thick cuts of meat.

Units of the GRILLVAPOR® power line are intended for high grilling service (fast cooking at high heat), as they are able to generate a temperature of over 400°C **spread uniformly across the entire cook-top** thanks to the use of **high efficiency burners** that cook foods by radiating heat. Moreover, they are equipped with a device for adjusting the height of the grid to enable instant regulation of the heat transmitted to the food. GRILLVAPOR® power units are especially suitable for: T-bone steaks, horse and buffalo meats, rump steaks, flank steaks, dry aged beef, and indeed any foods compatible with high grilling techniques.





 **GRILLVAPOR®**





GRILLVAPOR® POWER GAS TOP

Grillvapor gas da banco realizzato in acciaio inox AISI 304 - zone cottura a temperatura regolabile - grigliati cottura a tondino - dispositivo brevettato per regolare in altezza il grigliato in 2 posizioni, è applicato in ogni zona di cottura ed è indipendente nelle apparecchiature a due e tre moduli - accensione piezoelettrica - bruciatori completi di fiamma pilota e termocoppia di sicurezza - "cupole" brevettate in acciaio di nuova concezione - cassetti con vasca raccolta acqua a riempimento manuale - alimentazione a gas metano o GPL.

AISI 304 stainless steel gas-supplied Grillvapor for worktable - cooking surfaces with adjustable temperature - bar-type cooking gridirons - patented device for height adjustment of the grill top in 2 positions, applied in all cooking areas and independent in two and three-module grills - piezoelectric ignition - burners equipped with pilot flame and safety thermocouple - new concept patented steel "domes" - drawers equipped with manually-loaded water collector - LPG or natural gas supply.



Modello / Model	GV 407 P TOP	GV 807 P TOP	GV 1207 P TOP
Tipo / Type	Meccanica / Mechanical	Meccanica / Mechanical	Meccanica / Mechanical
Dimensioni ingombro Overall dimensions	420x700x440	800x700x440	1195x700x440
Dimensioni piano cottura Dimensions of cooking surface	390x470	760x470	1155x470
Alimentazione / Supply	Gas (3/4")	Gas (3/4")	Gas (3/4")
Voltaggio / Voltage	-	-	-
Potenza Elettrica - Electric Power kw	-	-	-
Potenza Gas - Gas Power kw	10,5	21	31,5
Consumo metano - mc/h-GPL Kg/h Consumption methane - mc/nh-LPG Kg/h	1,11 / 0,82	2,22 / 1,64	3,33 / 2,46
Costruzione / Building	Acc. Inox AISI 304 SC Brite Stainless steel AISI 304 Scoth Brite	Acc. Inox AISI 304 SC Brite Stainless steel AISI 304 Scoth Brite	Acc. Inox AISI 304 SC Brite Stainless steel AISI 304 Scoth Brite
Grigliato cottura / Grilled cooking	Tondino / Round	Tondino / Round	Tondino / Round
Regolazione piani cottura Adjusting device	Si	Si	Si
Allaccio idrico / Water connection	-	-	-
Carico acqua Water filling	Manuale / Manual	Manuale / Manual	Manuale / Manual
Sonda al cuore / Core probe	-	-	-
Volume imballo mc Packing volume mc	0,26	0,47	0,69
Peso lordo Kg / Gross Weight Kg	50	83	117

ACCESSORI / ACCESSORIES

FTI70	Fry top serie 700 gas / 700 Series Gas Fry top
GT70-1S*	Grigliato a tondino 1/2 modulo serie 700 con dispositivo sollevamento anteriore Half round shaped cooking gridiron 700 series with front lift device
GT90-1S*	Grigliato a tondino 1/2 modulo serie 900 con dispositivo sollevamento anteriore Half round shaped cooking gridiron 900 series with front lift device
GC70-1*	Grigliato a "V" 1/2 modulo serie 700 Half channeled shaped cooking gridiron 700 series
GDC70-1*	Grigliato a doppia "V" sovrapposta 1/2 modulo serie 700 Half double channeled overlapping shaped cooking gridiron 700 series
FTI90	Fry top serie 900 gas / 900 Series Gas Fry top
GC90-1*	Grigliato a "V" 1/2 modulo serie 900 Half channeled shaped cooking gridiron 900 series
GDC90-1*	Grigliato a doppia "V" sovrapposta 1/2 modulo serie 900 Half double channeled overlapping shaped cooking gridiron 900 series
B70/90	Gambe per serie el+gas top / Feet for all models TOP 700/900
SSPI	Spazzola / Brush
RAS-GAS	Raschietto per piano gas / Gas scraper
RG 200/R	Kit ruote girevoli / Kit wheels
01.236	Coppia supporto ripiani / Couple of shelf supports
01.237	Ripiano forato da applicare su cod. 01.236 Drilled shelf to be put on item's code 01.236
01.250	Ripiano supporto vaschetta GN1/3 da applicare su cod. 01.236. (vaschetta esclusa) Support bowl GN1/3 shelf to be put on item's code 01.236 (bowl is excluded)
CL47	Cloche per singolo modulo serie 700 / Cloche single cooking surface 700 series
CL49	Cloche per singolo modulo serie 900 / Cloche single cooking surface 900 series



GT70-1S - GT90-1S Dim. 190x470 Dim. 190x670	GC70-1 - GC90-1 Dim. 190x470 Dim. 190x670	GDC70-1 - GDC90-1 Dim. 190x470 Dim. 190x670	FTI70 - FTI90 Dim. 370x440 Dim. 370x644
--	--	--	--



B70/90	RAS-GAS	SSPI	CL47 / CL49
---------------	----------------	-------------	--------------------



01.237	01.236	01.250 Vaschetta non inclusa Bowl not included	RG 200/R Solo per MR/MC Only for MR/MC
---------------	---------------	---	---

* Per completare il modulo cottura utilizzare 2 pz. / * 2 pieces to cover the all cooking surface



GV 409 P TOP	GV 809 P TOP	GV 1209 P TOP
Meccanica / Mechanical	Meccanica / Mechanical	Meccanica / Mechanical
420x900x440	800x900x440	1195x900x440
390x670	760x670	1155x670
Gas (3/4")	Gas (3/4")	Gas (3/4")
-	-	-
-	-	-
13	26	39
1,37 / 1,02	2,75 / 2,03	4,13 / 3,05
Acc. Inox AISI 304 SC Brite Stainless steel AISI 304 Scoth Brite	Acc. Inox AISI 304 SC Brite Stainless steel AISI 304 Scoth Brite	Acc. Inox AISI 304 SC Brite Stainless steel AISI 304 Scoth Brite
Tondino / Round	Tondino / Round	Tondino / Round
Si	Si	Si
-	-	-
Manuale / Manual	Manuale / Manual	Manuale / Manual
-	-	-
0,33	0,60	0,87
57	98	137

**MOBILI PER GRILLVAPOR EL/GAS/TOP
CABINET FOR GRILLVAPOR EL/GAS/TOP**

Mobile Aperto Open cabinet	Dimensioni LxPxH Dimensions
MR47 (407)	420x555x450
MR87 (807)	800x555x450
MR127 (1207)	1195x555x450
MR49 (409)	420x755x450
MR89 (809)	800x755x450
MR129 (1209)	1195x755x450



Mobile Chiuso Closed cabinet	Dimensioni Dimensions
MC47 (407)	420x555x450
MC87 (807)	800x555x450
MC127 (1207)	1195x555x450
MC49 (409)	420x755x450
MC89 (809)	800x755x450
MC129 (1209)	1195x755x450

GRILLVAPOR® POWER GAS MONOBLOCCO

Grillvapor gas su mobile realizzato in acciaio inox AISI 304 - zone cottura a temperatura regolabile - grigliati cottura a tondino - dispositivo brevettato per regolare in altezza il grigliato in 2 posizioni, è applicato in ogni zona di cottura ed è indipendente nelle apparecchiature a due e tre moduli - accensione piezoelettrica - bruciatori completi di fiamma pilota e termocoppia di sicurezza - "cupole" brevettate in acciaio di nuova concezione - cassetto a guide scorrevoli con vasca raccolta acqua - allacciamento idrico - alimentazione a gas metano o GPL.

AISI 304 stainless steel gas-supplied Grillvapor built-in on the furniture - cooking surfaces with adjustable temperature - bar-type cooking gridirons - patented device for height adjustment of the grill top in 2 positions, applied in all cooking areas and independent in two and three-module grills - piezoelectric ignition - burners equipped with pilot flame and safety thermocouple - new concept patented steel "domes" - 1 drawer with slide-ways equipped with water collector - water connection - LPG or natural gas supply.



Modello / Model	GV 417 P	GV 817 P	GV 1217 P
Tipo / Type	Meccanica / Mechanical	Meccanica / Mechanical	Meccanica / Mechanical
Dimensioni ingombro Overall dimensions	420x700x850	800x700x850	1195x700x850
Dimensioni piano cottura Dimensions of cooking surface	390x470	760x470	1155x470
Alimentazione / Supply	Gas (3/4")	Gas (3/4")	Gas (3/4")
Voltaggio / Voltage	-	-	-
Potenza Elettrica - Electric Power kw	-	-	-
Potenza Gas - Gas Power kw	10,5	21	31,5
Consumo metano - mc/h-GPL Kg/h Consumption methane - mc/nh-LPG Kg/h	1,11 / 0,82	2,22 / 1,64	3,33 / 2,46
Costruzione / Building	Acc. Inox AISI 304 SC Brite Stainless steel AISI 304 Scoth Brite	Acc. Inox AISI 304 SC Brite Stainless steel AISI 304 Scoth Brite	Acc. Inox AISI 304 SC Brite Stainless steel AISI 304 Scoth Brite
Grigliato cottura / Grilled cooking	Tondino / Round	Tondino / Round	Tondino / Round
Regolazione piani cottura Adjusting device	Si	Si	Si
Allaccio idrico / Water connection	Si	Si	Si
Carico acqua Water filling	Manuale / Manual	Manuale / Manual	Manuale / Manual
Sonda al cuore / Core probe	-	-	-
Volume imballo mc Packing volume mc	0,35	0,62	0,90
Peso lordo Kg / Gross Weight Kg	61	98	132

ACCESSORI / ACCESSORIES

GT70-1S*	Grigliato a tondino 1/2 modulo serie 700 con dispositivo sollevamento anteriore <i>Half round shaped cooking gridiron 700 series with front lift device</i>
GT90-1S*	Grigliato a tondino 1/2 modulo serie 900 con dispositivo sollevamento anteriore <i>Half round shaped cooking gridiron 900 series with front lift device</i>
GC70-1*	Grigliato a "V" 1/2 modulo serie 700 / <i>Half channeled shaped cooking gridiron 700 series</i>
GDC70-1*	Grigliato a doppia "V" sovrapposta 1/2 modulo serie 700 <i>Half double channeled overlapping shaped cooking gridiron 700 series</i>
FT170	Fry top serie 700 gas / <i>700 Series Gas Fry top</i>
GC90-1*	Grigliato a "V" 1/2 modulo serie 900 / <i>Half channeled shaped cooking gridiron 900 series</i>
GDC90-1*	Grigliato a doppia "V" sovrapposta 1/2 modulo serie 900 <i>Half double channeled overlapping shaped cooking gridiron 900 series</i>
FT190	Fry top serie 900 gas / <i>900 Series Gas Fry top</i>
SSPI	Spazzola / <i>Brush</i>
RAS-GAS	Raschietto per piano gas / <i>Gas scraper</i>
01.236	Coppia supporto ripiani / <i>Couple of shelf supports</i>
01.237	Ripiano forato da applicare su cod. 01.236 / <i>Drilled shelf to be put on item's code 01.236</i>
01.250	Ripiano supporto vaschetta GN1/3 da applicare su cod. 01.236. (vaschetta esclusa) <i>Support bowl GN1/3 shelf to be put on item's code 01.236 (bowl is excluded)</i>
CL47	Cloche per singolo modulo serie 700 / <i>Cloche single cooking surface 700 series</i>
CL49	Cloche per singolo modulo serie 900 / <i>Cloche single cooking surface 900 series</i>

* Per completare il modulo cottura utilizzare 2 pz
* 2 pieces to cover the all cooking surface



GV 419 P	GV 819 P	GV 1219 P
Meccanica / Mechanical	Meccanica / Mechanical	Meccanica / Mechanical
420x900x850	800x900x850	1195x900x850
390x670	760x670	1155x670
Gas (3/4")	Gas (3/4")	Gas (3/4")
-	-	-
-	-	-
13	26	39
1,37 / 1,02	2,75 / 2,03	4,13 / 3,05
Acc. Inox AISI 304 SC Brite Stainless steel AISI 304 Scoth Brite	Acc. Inox AISI 304 SC Brite Stainless steel AISI 304 Scoth Brite	Acc. Inox AISI 304 SC Brite Stainless steel AISI 304 Scoth Brite
Tondino / Round	Tondino / Round	Tondino / Round
Si	Si	Si
Si	Si	Si
Manuale / Manual	Manuale / Manual	Manuale / Manual
-	-	-
0,44	0,78	1,15
73	113	1,53



GT70-1S - GT90-1S Dim. 190x470
Dim. 190x670

GC70-1 - GC90-1 Dim. 190x470
Dim. 190x670

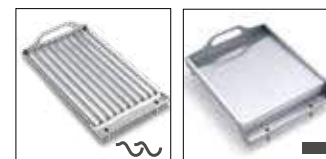

GDC70-1 - GDC90-1 Dim. 190x470
Dim. 190x670

FT170 - FT190 Dim. 370x440
Dim. 370x644



RG 200/R

RAS-GAS



SSPI

CL47 / CL49

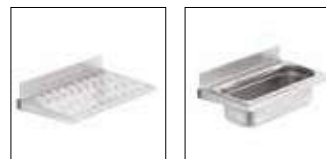

01.237

01.250
Vaschetta non inclusa
Bowl not included



01.236

DI SERIE SU POWER / POWER STANDARD

OPTIONAL

GRILLVAPOR® MECCANICO / MECHANICAL

Arris Catering Equipment® ha iniziato la sua produzione nel 1993 con una precedente versione di questa linea che, ad oggi, è arrivata alla sua quarta edizione, sempre migliorata e perfezionata. GRILLVAPOR® meccanico rimane ancora **il nostro best seller** ed è considerata la griglia più **resistente e affidabile** sul mercato, anche quando viene sottoposta a **condizioni di lavoro estreme**.

La GRILLVAPOR® meccanica è caratterizzata da una facile manutenzione ed un'estrema affidabilità.

La tecnologia GRILLVAPOR® che noi applichiamo alle nostre apparecchiature è l'unica che permette di ottenere i seguenti benefici sugli alimenti:

- **Migliori risultati organolettici**
(rispetto a forni, piastre, pietra lavica, etc.)
- **Minore calo peso del cibo** (in media -20%)
- **Cottura sana e genuina** (i nutrienti rimangono all'interno)
- **Cotture più veloci** (+20%)
- **Colori degli alimenti più vivi** e brillanti

Le nostre innovazioni tecniche vi permettono i seguenti benefici economici:

- **Uniformità di temperatura** sul piano di cottura
- **Facile pulizia**
- **Migliore assorbimento dello shock** termico
- **Alta affidabilità** nel tempo

Arris Catering Equipment® began production in 1993 with an earlier version of this same line, which is now into its fourth edition, further enhanced and improved. GRILLVAPOR® Mechanical still remains **our best-seller today**, and is regarded as the **toughest and most reliable** grill on the market, even when doing service under **extreme operating conditions**. All GRILLVAPOR® mechanical models are characterized by **ease of maintenance and matchless reliability**.

The GRILLVAPOR® technology incorporated into our appliances is the only one able to provide the following benefits for food preparation:

- **Better organoleptic results**
(compared to ovens, griddles, lava stone grills, etc.)
- **Less weight loss in cooking** (-20% on average)
- **Healthy and wholesome cooking** (foods retain their nutrients)
- **Faster cooking** (+20%)
- Food colours **remain sharp and bright**

Our engineering innovations provide the following economic benefits:

- **Uniform temperature** across the cook-top
- **Easy cleaning**
- Better **absorption of thermal shock**
- **High reliability** over time





 **GRILLVAPOR®**





GRILLVAPOR® EL TOP

Grillvapor Elettrico da banco realizzato in acciaio inox AISI 304 - zone cottura temperature regolabili cassetti con vasca raccolta acqua a riempimento manuale - piano cottura ribaltabile.

AISI 304 stainless steel electric Grillvapor for worktable - cooking surfaces with adjustable temperature - drawers equipped with manually-loaded water collector - Tip-up cook-top.



Modello / Model	GV 407 EL TOP *GV 407 EL/M TOP	GV 807 EL TOP	GV 1207 EL TOP
Tipo / Type	Meccanica / Mechanical	Meccanica / Mechanical	Meccanica / Mechanical
Dimensioni ingombro Overall dimensions	420x700x440	800x700x440	1195x700x440
Dimensioni piano cottura Dimensions of cooking surface	390x530	760x530	1155x530
Alimentazione / Supply	Elettrica / Electric	Elettrica / Electric	Elettrica / Electric
Voltaggio / Voltage	400V3N - 7,5A - 50/60Hz 230 V3 - 13A - 50/60Hz 230V - 22,6A - 50/60Hz *	400V3N - 15A - 50/60Hz 230V3 - 26,1A - 50/60Hz	400V3N - 22,5A - 50/60Hz 230V3 - 39,2A - 50/60Hz
Potenza Elettrica - Electric Power kw	5,2	10,4	15,6
Potenza Gas - Gas Power kw	-	-	-
Consumo metano - mc/h-GPL Kg/h Consumption methane - mc/nh-LPG Kg/h	-	-	-
Costruzione / Building	Acc. Inox AISI 304 SC Brite Stainless steel AISI 304 Scoth Brite	Acc. Inox AISI 304 SC Brite Stainless steel AISI 304 Scoth Brite	Acc. Inox AISI 304 SC Brite Stainless steel AISI 304 Scoth Brite
Grigliato cottura / Grilled cooking	Tondino / Round	Tondino / Round	Tondino / Round
Regolazione piani cottura Adjusting device	-	-	-
Allaccio idrico / Water connection	-	-	-
Carico acqua Water filling	Manuale / Manual	Manuale / Manual	Manuale / Manual
Sonda al cuore / Core probe	-	-	-
Volume imballo mc Packing volume mc	0,26	0,47	0,69
Peso lordo Kg / Gross Weight Kg	50	83	117

* Per voltaggio 230V Monofase specificare all'ordine GV470EL/M Top solo per questo modello./ * Voltage 230V single phase must be specified as GV470EL/M Top at the moment of the order.

ACCESSORI / ACCESSORIES

FT170E	Fry top serie 700 elettriche / <i>700 Series Electric Fry top</i>
FT190E	Fry top serie 900 elettriche / <i>900 Series Electric Fry top</i>
B70/90	Gambe per serie el+gas top / <i>Feet for all models TOP 700/900</i>
SSPI	Spazzola / <i>Brush</i>
RAS-EL	Raschietto per piano cottura elettrico / <i>Electric scraper</i>
RG 200/R	Kit ruote girevoli / <i>Kit wheels</i>
1.910	Paraschizzi completo 407-417 / <i>Complete splashboard frame 407-417</i>
1.911	Paraschizzi completo 409-419 / <i>Complete splashboard frame 409-419</i>
1.912	Paraschizzi completo 807-817 / <i>Complete splashboard frame 807-817</i>
1.913	Paraschizzi completo 809-819 / <i>Complete splashboard frame 809-819</i>
1.914	Paraschizzi completo 1207-1217 / <i>Complete splashboard frame 1207-1217</i>
1.915	Paraschizzi completo 1209-1219 / <i>Complete splashboard frame 1209-1219</i>
01.236	Coppia supporto ripiani / <i>Couple of shelf supports</i>
01.237	Ripiano forato da applicare su cod. 01.236 / <i>Drilled shelf to be put on item's code 01.236</i>
01.250	Ripiano supporto vaschette GN1/3 da applicare su cod. 01.236. (vaschetta esclusa) <i>Support bowl GN1/3 shelf to be put on item's code 01.236 (bowl is excluded)</i>
CL47	Cloche per singolo modulo serie 700 / <i>Cloche single cooking surface 700 series</i>
CL49	Cloche per singolo modulo serie 900 / <i>Cloche single cooking surface 900 series</i>
C070	Copertura in acciaio inox per pulizia modulo da 700 <i>Top cover for cleaning in stainless steel suitable for serie 700</i>
C090	Copertura in acciaio inox per pulizia modulo da 900 <i>Top cover for cleaning in stainless steel suitable for serie 900</i>



GV 409 EL TOP	GV 809 EL TOP
Meccanica / Mechanical	Meccanica / Mechanical
420x900x440	800x900x440
390x730	760x730
Elettrica / Electric	Elettrica / Electric
400V3N - 11,3A - 50/60Hz 230V3 - 19,6A - 50/60Hz	400V3N - 22,5A - 50/60Hz 230V3 - 32,2A - 50/60Hz
7,8	15,6
-	-
-	-
Acc. Inox AISI 304 SC Brite Stainless steel AISI 304 Scotch Brite	Acc. Inox AISI 304 SC Brite Stainless steel AISI 304 Scotch Brite
Tondino / Round	Tondino / Round
-	-
-	-
Manuale / Manual	Manuale / Manual
-	-
0,33	0,60
57	98

FT170E - FT190E
Dim. 370x474
Dim. 370x674

KS01

B70/90

RAS-EL

SSPI

RG 200/R
Solo per MR/MC
Only for MR/MC

CL47 / CL49

01.237

01.250
Vaschetta non inclusa
Bowl not included

01.236

1.910 / 1.911
1.912 / 1.913
1.914 / 1.915

C070
C090
**MOBILI PER GRILLVAPOR EL/GAS/TOP
CABINET FOR GRILLVAPOR EL/GAS/TOP**

Mobile Aperto <i>Open cabinet</i>	Dimensioni LxPxH <i>Dimensions</i>
MR47 (407)	420x555x450
MR87 (807)	800x555x450
MR127 (1207)	1195x555x450
MR49 (409)	420x755x450
MR89 (809)	800x755x450
MR129 (1209)	1195x755x450



Mobile Chiuso <i>Closed cabinet</i>	Dimensioni LxPxH <i>Dimensions</i>
MC47 (407)	420x555x450
MC87 (807)	800x555x450
MC127 (1207)	1195x555x450
MC49 (409)	420x755x450
MC89 (809)	800x755x450
MC129 (1209)	1195x755x450

GRILLVAPOR® GAS TOP

Grillvapor gas da banco realizzato in acciaio inox AISI 304 - zone cottura a temperatura regolabile - grigliati cottura a tondino - accensione piezoelettrica - bruciatori completi di fiamma pilota e termocoppia di sicurezza - cassette con vasca raccolta acqua a riempimento manuale - alimentazione a gas metano o GPL.

AISI 304 stainless steel gas-supplied Grillvapor for worktable - cooking surfaces with adjustable temperature - bar-type cooking gridirons - piezoelectric ignition - burners equipped with pilot flame and safety thermocouple - drawers equipped with manually-loaded water collector - LPG or natural gas supply.



Modello / Model	GV 407 TOP	GV 807 TOP	GV 1207 TOP
Tipo / Type	Meccanica / Mechanical	Meccanica / Mechanical	Meccanica / Mechanical
Dimensioni ingombro <i>Overall dimensions</i>	420x700x440	800x700x440	1195x700x440
Dimensioni piano cottura <i>Dimensions of cooking surface</i>	390x470	770x470	1155x470
Alimentazione / Supply	Gas (3/4")	Gas (3/4")	Gas (3/4")
Voltaggio / Voltage	-	-	-
Potenza Elettrica - Electric Power kw	-	-	-
Potenza Gas - Gas Power kw	10,5	21	31,5
Consumo metano - mc/h-GPL Kg/h <i>Consumption methane - mc/nh-LPG Kg/h</i>	1,1 / 0,82	2,22 / 1,64	3,33 / 2,46
Costruzione / Building	Acc. Inox AISI 304 SC Brite Stainless steel AISI 304 Scoth Brite	Acc. Inox AISI 304 SC Brite Stainless steel AISI 304 Scoth Brite	Acc. Inox AISI 304 SC Brite Stainless steel AISI 304 Scoth Brite
Grigliato cottura / Grilled cooking	Tondino / Round	Tondino / Round	Tondino / Round
Regolazione piani cottura <i>Adjusting device</i>	Optional (1xReg90)	Optional (2xReg70)	Optional (3xReg70)
Allaccio idrico / Water connection	-	-	-
Carico acqua <i>Water filling</i>	Manuale / Manual	Manuale / Manual	Manuale / Manual
Sonda al cuore / Core probe	-	-	-
Volume imballo mc <i>Packing volume mc</i>	0,26	0,47	0,69
Peso lordo Kg / Gross Weight Kg	50	83	117

FTI70	Fry top serie 700 gas / 700 Series Gas Fry top
GC70-1*	Grigliato a "V" 1/2 modulo serie 700 / Half channeled shaped cooking gridiron 700 series
GDC70-1*	Grigliato a doppia "V" sovrapposta 1/2 modulo serie 700 Half double channeled overlapping shaped cooking gridiron 700 series
GT70-1*	Grigliato a tondino 1/2 modulo serie 700 / Half round shaped cooking gridiron 700 series
KIT ANTI 70	Dispositivo antincendio singolo bruciatore 700 - Kit fire-fighting device for single burner serie 700
FTI90	Fry top serie 900 gas / 900 Series Gas Fry top
GC90-1*	Grigliato a "V" 1/2 modulo serie 900 / Half channeled shaped cooking gridiron 900 series
GDC90-1*	Grigliato a doppia "V" sovrapposta 1/2 modulo serie 900 Half double channeled overlapping shaped cooking gridiron 900 series
GT90-1*	Grigliato a tondino 1/2 modulo serie 900 / Half round shaped cooking gridiron 900 series
KIT ANTI 90	Dispositivo antincendio singolo bruciatore 900 / Kit fire-fighting device for single burner serie 900
B70/90	Gambe per serie el+gas top / Feet for all models TOP 700/900
SSPI	Spazzola / Brush
RAS-GAS	Raschietto per piano gas / Gas scraper
RG 200/R	Kit ruote girevoli / Kit wheels
1.910	Paraschizzi completo 407-417 / Complete splashboard frame 407-417
1.911	Paraschizzi completo 409-419 / Complete splashboard frame 409-419
1.912	Paraschizzi completo 807-817 / Complete splashboard frame 807-817
1.913	Paraschizzi completo 809-819 / Complete splashboard frame 809-819
1.914	Paraschizzi completo 1207-1217 / Complete splashboard frame 1207-1217
1.915	Paraschizzi completo 1209-1219 / Complete splashboard frame 1209-1219
01.236	Coppia supporto ripiani / Couple of shelf supports
01.237	Ripiano forato da applicare su cod. 01.236 / Drilled shelf to be put on item's code 01.236
01.250	Ripiano supporto vaschette GN1/3 da applicare su cod. 01.236. (vaschetta esclusa) Support bowl GN1/3 shelf to be put on item's code 01.236 (bowl is excluded)
CL47	Cloche per singolo modulo serie 700 / Cloche single cooking surface 700 series
CL49	Cloche per singolo modulo serie 900 / Cloche single cooking surface 900 series

* Per completare il modulo cottura utilizzare 2 pz. / * 2 pieces to cover the all cooking surface



GV 409 TOP	GV 809 TOP	GV 1209 TOP
Meccanica / Mechanical	Meccanica / Mechanical	Meccanica / Mechanical
420x900x440	800x900x440	1195x900x440
390x670	760x670	1155x670
Gas (3/4")	Gas (3/4")	Gas (3/4")
-	-	-
-	-	-
13	26	39
1,37 / 2,46	2,75 / 2,03	4,13 / 3,05
Acc. Inox AISI 304 SC Brite Stainless steel AISI 304 Scoth Brite	Acc. Inox AISI 304 SC Brite Stainless steel AISI 304 Scoth Brite	Acc. Inox AISI 304 SC Brite Stainless steel AISI 304 Scoth Brite
Tondino / Round	Tondino / Round	Tondino / Round
Optional (1xReg90)	Optional (2xReg90)	Optional (3xReg90)
-	-	-
Manuale / Manual	Manuale / Manual	Manuale / Manual
-	-	-
0,33	0,6	0,87
57	98	137



GT70-1 - GT90-1
Dim. 190x470
Dim. 190x670



GC70-1 - GC90-1
Dim. 190x470
Dim. 190x670



GDC70-1 - GDC90-1
Dim. 190x470
Dim. 190x670



FTI70 - FTI90
Dim. 370x440
Dim. 370x644



**KIT ANTI 70
KIT ANTI 90**



RAS-GAS



SSPI



RG 200/R
Solo per MR/MC
Only for MR/MC



B70/90



CL47 / CL49



01.237



01.250
Vaschetta non inclusa
Bowl not included



01.236



Mobile Aperto Open cabinet	Dimensioni LxPxH Dimensions
MR47 (407)	420x555x450
MR87 (807)	800x555x450
MR127 (1207)	1195x555x450
MR49 (409)	420x755x450
MR89 (809)	800x755x450
MR129 (1209)	1195x755x450



Mobile Chiuso Closed cabinet	Dimensioni Dimensions
MC47 (407)	420x555x450
MC87 (807)	800x555x450
MC127 (1207)	1195x555x450
MC49 (409)	420x755x450
MC89 (809)	800x755x450
MC129 (1209)	1195x755x450

GRILLVAPOR® EL MONOBLOCCO

Grillvapor Elettrico su mobile realizzato in acciaio inox AISI 304 - zone cottura a temperature regolabili - cassetto a guide scorrevoli con vasca raccolta acqua - predisposto allacciamento idrico - piano cottura ribaltabile.

AISI 304 stainless steel electric Grillvapor built-in on the furniture - cooking surfaces measuring adjustable temperature - drawer with slide-ways equipped with water collector - water connection prearranged - Tip-up cook-top.



Modello / Model	GV 417 EL *GV 417 EL/M	GV 817 EL	GV 1217 EL
Tipo / Type	Meccanica / Mechanical	Meccanica / Mechanical	Meccanica / Mechanical
Dimensioni ingombro Overall dimensions	420x700x850	800x700x850	1195x700x850
Dimensioni piano cottura Dimensions of cooking surface	390x530	760x530	1155x530
Alimentazione / Supply	Elettrica / Electric	Elettrica / Electric	Elettrica / Electric
Voltaggio/ Voltage	400V3N - 7,5A - 50/60Hz 230 V3 - 13A - 50/60Hz 230V - 22,6A - 50/60Hz*	400V3N - 15A - 50/60Hz 230V3 - 26,1A - 50/60Hz	400V3N - 22,5A - 50/60Hz 230V3 - 39,2A - 50/60Hz
Potenza Elettrica - Electric Power kw	5,2	10,4	15,6
Potenza Gas - Gas Power kw	-	-	-
Consumo metano - mc/h-GPL Kg/h Consumption methane - mc/nh-LPG Kg/h	-	-	-
Costruzione / Building	Acc. Inox AISI 304 SC Brite Stainless steel AISI 304 Scoth Brite	Acc. Inox AISI 304 SC Brite Stainless steel AISI 304 Scoth Brite	Acc. Inox AISI 304 SC Brite Stainless steel AISI 304 Scoth Brite
Grigliato cottura / Grilled cooking	Tondino / Round	Tondino / Round	Tondino / Round
Regolazione piani cottura Adjusting device	-	-	-
Allaccio idrico / Water connection	Si	Si	Si
Carico acqua Water filling	Manuale / Manual	Manuale / Manual	Manuale / Manual
Sonda al cuore / Core probe	-	-	-
Volume imballo mc Packing volume mc	0,35	0,62	0,90
Peso lordo Kg / Gross Weight Kg	61	98	132

* Per voltaggio 230V Monofase specificare all'ordine GV417EL/M solo per questo modello./ * Voltage 230V single phase must be specified as GV417EL/M at the moment of the order.

ACCESSORI / ACCESSORIES

FT170E	Fry top serie 700 elettriche / 700 Series Electric Fry top
FT190E	Fry top serie 900 elettriche / 900 Series Electric Fry top
SSPI	Spazzola / Brush
RAS-EL	Raschietto per piano cottura elettrico / Electric scraper
RG 200/R	Kit ruote girevoli / Kit wheels
1.910	Paraschizzi completo 407-417 / Complete splashboard frame 407-417
1.911	Paraschizzi completo 409-419 / Complete splashboard frame 409-419
1.912	Paraschizzi completo 807-817 / Complete splashboard frame 807-817
1.913	Paraschizzi completo 809-819 / Complete splashboard frame 809-819
1.914	Paraschizzi completo 1207-1217 / Complete splashboard frame 1207-1217
1.915	Paraschizzi completo 1209-1219 / Complete splashboard frame 1209-1219
01.236	Coppia supporto ripiani / Couple of shelf supports
01.237	Ripiano forato da applicare su cod. 01.236 / Drilled shelf to be put on item's code 01.236
01.250	Ripiano supporto vaschette GN1/3 da applicare su cod. 01.236. (vaschetta esclusa) Support bowl GN1/3 shelf to be put on item's code 01.236 (bowl is excluded)
CL47	Cloche per singolo modulo serie 700 / Cloche single cooking surface 700 series
CL49	Cloche per singolo modulo serie 900 / Cloche single cooking surface 900 series
C070	Copertura in acciaio inox per pulizia modulo da 700 Top cover for cleaning in stainless steel suitable for serie 700
C090	Copertura in acciaio inox per pulizia modulo da 900 Top cover for cleaning in stainless steel suitable for serie 900

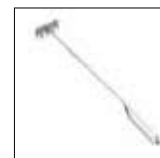
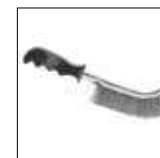
FT170E - FT190E
 Dim. 370x474
 Dim. 370x674

RAS-EL

SSPI

RG 200/R

CL47 / CL49

01.237

01.250
 Vaschetta non inclusa
 Bowl not included

01.236

1.910 / 1.911
1.912 / 1.913
1.914 / 1.915

C070
C090

GV 419 EL	GV 819 EL
Meccanica / Mechanical	Meccanica / Mechanical
420x900x850	800x900x850
390x730	760x730
Elettrica / Electric	Elettrica / Electric
400V3N - 11,3A - 50/60Hz 230V3 - 19,6A - 50/60Hz	400V3N - 22,5A - 50/60Hz 230V3 - 32,2A - 50/60Hz
7,8	15,6
-	-
Acc. Inox AISI 304 SC Brite Stainless steel AISI 304 Scotch Brite	Acc. Inox AISI 304 SC Brite Stainless steel AISI 304 Scotch Brite
Tondino / Round	Tondino / Round
-	-
Si	Si
Manuale / Manual	Manuale / Manual
-	-
0,44	0,78
73	113

GRILLVAPOR® GAS MONOBLOCCO

Grillvapor gas su mobile realizzato in acciaio inox AISI 304 - zone cottura a temperatura regolabile - grigliati cottura a tondino - accensione piezoelettrica - bruciatori completi di fiamma pilota e termocoppia di sicurezza - cassetto a guide scorrevoli con vasca raccolta acqua - allacciamento idrico - alimentazione a gas metano o GPL.

AISI 304 stainless steel gas-supplied Grillvapor built-in on the furniture - cooking surfaces with adjustable temperature - bar-type cooking gridirons - piezoelectric ignition - burners equipped with pilot flame and safety thermocouple - drawer with slide-ways equipped with water collector - water connection - LPG or natural gas supply.



Modello / Model	GV 417	GV 817	GV 1217
Tipo / Type	Meccanica / Mechanical	Meccanica / Mechanical	Meccanica / Mechanical
Dimensioni ingombro Overall dimensions	420x700x850	800x700x850	1195x700x850
Dimensioni piano cottura Dimensions of cooking surface	390x470	760x470	1155x470
Alimentazione / Supply	Gas (3/4")	Gas (3/4")	Gas (3/4")
Voltaggio / Voltage	-	-	-
Potenza Elettrica - Electric Power kw	-	-	-
Potenza Gas - Gas Power kw	10,5	21	31,5
Consumo metano - mc/h-GPL Kg/h Consumption methane - mc/nh-LPG Kg/h	1,11 / 0,82	2,22 / 1,64	3,33 / 2,46
Costruzione / Building	Acc. Inox AISI 304 SC Brite Stainless steel AISI 304 Scoth Brite	Acc. Inox AISI 304 SC Brite Stainless steel AISI 304 Scoth Brite	Acc. Inox AISI 304 SC Brite Stainless steel AISI 304 Scoth Brite
Grigliato cottura / Grilled cooking	Tondino / Round	Tondino / Round	Tondino / Round
Regolazione piani cottura Adjusting device	Optional (1xREG70)	Optional (2xREG70)	Optional (2xREG70)
Allaccio idrico / Water connection	Si	Si	Si
Carico acqua Water filling	Manuale / Manual	Manuale / Manual	Manuale / Manual
Sonda al cuore / Core probe	-	-	-
Volume imballo mc Packing volume mc	0,35	0,62	0,90
Peso lordo Kg / Gross Weight Kg	61	98	132

FTI70	Fry top serie 700 gas / 700 Series Gas Fry top
GT70-1*	Grigliato a tondino 1/2 modulo serie 700 / Half round shaped cooking gridiron 700 series
GC70-1*	Grigliato a "V" 1/2 modulo serie 700 / Half channeled shaped cooking gridiron 700 series
GDC70-1*	Grigliato a doppia "V" sovrapposta 1/2 modulo serie 700 Half double channeled overlapping shaped cooking gridiron 700 series
KIT ANTI 70	Dispositivo antincendio singolo bruciatore 700 - Kit fire-fighting device for single burner serie 700
FTI90	Fry top serie 900 gas / 900 Series Gas Fry top
GT90-1*	Grigliato a tondino 1/2 modulo serie 900 / Half round shaped cooking gridiron 900 series
GC90-1*	Grigliato a "V" 1/2 modulo serie 900 / Half channeled shaped cooking gridiron 900 series
GDC90-1	Grigliato a doppia "V" sovrapposta 1/2 modulo serie 900 Half double channeled overlapping shaped cooking gridiron 900 series
KIT ANTI 90	Dispositivo antincendio singolo bruciatore 900 / Kit fire-fighting device for single burner serie 900
SSPI	Spazzola / Brush
RAS-GAS	Raschietto per piano gas / Gas scraper
RG 200/R	Kit ruote girevoli / Kit wheels
1.910	Paraschizzi completo 407-417 / Complete splashboard frame 407-417
1.911	Paraschizzi completo 409-419 / Complete splashboard frame 409-419
1.912	Paraschizzi completo 807-817 / Complete splashboard frame 807-817
1.913	Paraschizzi completo 809-819 / Complete splashboard frame 809-819
1.914	Paraschizzi completo 1207-1217 / Complete splashboard frame 1207-1217
1.915	Paraschizzi completo 1209-1219 / Complete splashboard frame 1209-1219
01.236	Coppia supporto ripiani / Couple of shelf supports
01.237	Ripiano forato da applicare su cod. 01.236 / Drilled shelf to be put on item's code 01.236
01.250	Ripiano supporto vaschetta GN1/3 da applicare su cod. 01.236. (vaschetta esclusa) Support bowl GN1/3 shelf to be put on item's code 01.236 (bowl is excluded)
CL47	Cloche per singolo modulo serie 700 / Cloche single cooking surface 700 series
CL49	Cloche per singolo modulo serie 900 / Cloche single cooking surface 900 series

* Per completare il modulo cottura utilizzare 2 pz / * 2 pieces to cover the all cooking surface



GV 419	GV 819	GV 1219
Meccanica / Mechanical	Meccanica / Mechanical	Meccanica / Mechanical
420x900x850	800x900x850	1195x900x850
390x670	760x670	1155x670
Gas (3/4")	Gas (3/4")	Gas (3/4")
-	-	-
-	-	-
13	26	39
1,37 / 1,02	2,75 / 2,03	4,13 / 3,05
Acc. Inox AISI 304 SC Brite Stainless steel AISI 304 Scoth Brite	Acc. Inox AISI 304 SC Brite Stainless steel AISI 304 Scoth Brite	Acc. Inox AISI 304 SC Brite Stainless steel AISI 304 Scoth Brite
Tondino / Round	Tondino / Round	Tondino / Round
Optional (1xREG90)	Optional (2xREG90)	Optional (2xREG90)
Si	Si	Si
Manuale / Manual	Manuale / Manual	Manuale / Manual
-	-	-
0,44	0,78	1,15
73	113	153



GT70-1 - GT90-1
Dim. 190x470
Dim. 190x670



GC70-1 - GC90-1
Dim. 190x470
Dim. 190x670



GDC70-1 - GDC90-1
Dim. 190x470
Dim. 190x670



FTI70 - FTI90
Dim. 370x440
Dim. 370x644



KIT ANTI 70
KIT ANTI 90



RG 200/R



RAS-GAS



SSPI



CL47 / CL49



01.237



01.250
Vaschetta non inclusa
Bowl not included



01.236



1.910 / 1.911
1.912 / 1.913
1.914 / 1.915

GRILLVAPOR® COMPACT

Questa speciale linea di prodotti, pur mantenendo le caratteristiche di cottura e i benefici delle grillvapor tradizionali, sono state ideate per una perfetta **razionalizzazione dello spazio in cucina**.

Le Grillvapor compact sono dotate di carico e scarico dell'acqua manuale, di **comandi semplici e intuitivi** e sono ideali per essere posizionate su tavoli e/o basi refrigerate senza interferire con la refrigerazione, questo al fine di **grigliare al meglio anche nelle cucine più piccole**. Le Grillvapor linea compact posizionate sulle nostre basi refrigerate **migliorano l'efficienza del personale**, velocizzano la produzione e limitano gli spostamenti del personale stesso. Sono disponibili anche su mobile aperto o chiuso. Ideali per i food truck e per i catering mobili.

The aim behind this special line of products, which retains all the culinary and economic advantages guaranteed by traditional grillvapor units, is to achieve a perfect **rationalization of space in the kitchen**.

With products of the Grillvapor compact line, the water tray is filled and emptied manually, the controls are **simple and intuitive** and the units are ideal for placing on tables and/or refrigerated bases without affecting the cooling system, so that food can be **grilled to perfection even in the smallest of kitchens**. Positioned on Arris refrigerated bases, Grillvapor compact units help to **improve the efficiency** of kitchen staff, speed up production, and minimize the movements that staff are required to make. Grillvapor compact units are also available on open or enclosed cabinets. Ideal for food trucks and for mobile caterers.



 GRILLVAPOR[®]

 GRILLVAPOR[®]





GRILLVAPOR® COMPACT EL TOP

Grillvapor Elettrico da banco realizzato in acciaio inox - zone cottura a temperature regolabili - cassetti con vasca raccolta acqua a riempimento manuale - Piano cottura ribaltabile.

Stainless steel electric Grillvapor for worktable - cooking surfaces with adjustable temperature 2 drawers equipped with manually-loaded water collector - Tip-up cook-top.



Modello / Model	GV 455 EL TOP *GV 455 EL/M TOP	GV 855 EL TOP	GV 1255 EL TOP
Tipo / Type	Meccanica / Mechanical	Meccanica / Mechanical	Meccanica / Mechanical
Dimensioni ingombro Overall dimensions	420x550x315	800x550x315	1195x550x315
Dimensioni piano cottura Dimensions of cooking surface	390x380	760x380	1155x380
Alimentazione / Supply	Elettrica / Electric	Elettrica / Electric	Elettrica / Electric
Voltaggio / Voltage	400V3N - 5,5A - 50/60Hz 230 V3 - 9,5A - 50/60Hz 230V - 16,5A - 50/60Hz *	400V3N - 11A - 50/60Hz 230V3 - 19A - 50/60Hz	400V3N - 16,5A - 50/60Hz 230V3 - 28,6A - 50/60Hz
Potenza Elettrica - Electric Power kw	3,8	7,6	11,4
Potenza Gas - Gas Power kw	-	-	-
Consumo metano - mc/h-GPL Kg/h Consumption methane - mc/nh-LPG Kg/h	-	-	-
Costruzione / Building	Acc. Inox SC Brite Stainless steel Scoth Brite	Acc. Inox SC Brite Stainless steel Scoth Brite	Acc. Inox SC Brite Stainless steel Scoth Brite
Grigliato cottura / Grilled cooking	Tondino / Round	Tondino / Round	Tondino / Round
Regolazione piani cottura Adjusting device	-	-	-
Allaccio idrico / Water connection	-	-	-
Carico acqua Water filling	Manuale / Manual	Manuale / Manual	Manuale / Manual
Sonda al cuore / Core probe	-	-	-
Volume imballo mc Packing volume mc	0,13	0,21	0,34
Peso lordo Kg / Gross Weight Kg	30	50	75

* Per voltaggio 230V Monofase specificare all'ordine GV455EL/M Top solo per questo modello./ * Voltage 230V single phase must be specified as GV455EL/M Top at the moment of the order.

ACCESSORI / ACCESSORIES

FTI55E	Fry top Serie 550EL / Fry top serie 550EL
FTI70E	Fry top serie 770EL/700EL/710EL / Fry top serie 770EL/700EL/710EL
B-55/77	Gambe per serie EL+GAS 550/770 TOP / Feet for models EL+GAS 550/770 TOP
SSPI	Spazzola / Brush
RAS-EL	Raschietto per piano elettrico / Electric scraper
RG 200/R	Kit ruote girevoli (Solo per MR) / Kit wheels (Only for MR)

FTI55E - FTI70E
 Dim. 370x330
 Dim. 370x474

B55/77

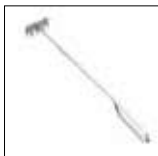
RG 200/R

RAS-EL

SSPI
**MOBILI PER GRILLVAPOR EL/GAS/TOP
CABINET FOR GRILLVAPOR EL/GAS/TOP**

Mobile Aperto Open cabinet	Dimensioni LxPxH Dimensions
MR455 (455)	420x440x550
MR855 (855)	800x440x550
MR1255 (1255)	1195x440x550
MR470 (470)	420x590x550
MR870 (870)	800x590x550
MR1270 (1270)	1195x590x550



GV 470 EL TOP *GV 470 EL/M TOP	GV 870 EL TOP	GV 1270 EL TOP	G3510E
Meccanica / Mechanical	Meccanica / Mechanical	Meccanica / Mechanical	Meccanica / Mechanical
420x700x315	800x700x315	1195x700x315	280x500x140
390x530	760x530	1195x530	250x350
Elettrica / Electric	Elettrica / Electric	Elettrica / Electric	Elettrica / Electric
400V3N - 7,5A - 50/60Hz 230 V3 - 13A - 50/60Hz 230V - 22,6A - 50/60Hz *	400V3N - 15A - 50/60Hz 230V3 - 26,1A - 50/60Hz	400V3N - 22,5A - 50/60Hz 230V3 - 39,2A - 50/60Hz	230V3 - 12,2A - 50/60Hz
5,2	10,4	15,6	2,8
-	-	-	-
-	-	-	-
Acc. Inox SC Brite Stainless steel Scotch Brite	Acc. Inox SC Brite Stainless steel Scotch Brite	Acc. Inox SC Brite Stainless steel Scotch Brite	Acc. Inox SC Brite Stainless steel Scotch Brite
Tondino / Round	Tondino / Round	Tondino / Round	Tondino / Round
-	-	-	-
-	-	-	-
Manuale / Manual	Manuale / Manual	Manuale / Manual	Manuale / Manual
-	-	-	-
0,18	0,35	0,56	0,05
40	58	105	9

* Per voltaggio 230V Monofase specificare all'ordine GV470EL/M Top solo per questo modello. / * Voltage 230V single phase must be specified as GV470EL/M Top at the moment of the order.

GRILLVAPOR® COMPACT GAS TOP

Grillvapor gas da banco realizzato in acciaio inox - zone cottura a temperature regolabili - grigliati cottura a tondino - accensione piezoelettrica - bruciatori completi di fiamma pilota e termocoppia di sicurezza - cassetti con vasca raccolta acqua a riempimento manuale - alimentazione a gas metano o GPL.

Stainless steel gas-supplied Grillvapor for worktable - cooking surfaces with adjustable temperature - bar-type cooking gridirons - piezoelectric ignition - burners equipped with pilot flame and safety thermocouple - drawers equipped with manually-loaded water collector - LPG or natural gas supply.



Modello / Model	GV 455 TOP	GV 855 TOP	GV 1255 TOP	GV 470 TOP
Tipo / Type	Meccanica / Mechanical	Meccanica / Mechanical	Meccanica / Mechanical	Meccanica / Mechanical
Dimensioni ingombro Overall dimensions	420x550x315	800x550x315	1195x550x315	420x700x315
Dimensioni piano cottura Dimensions of cooking surface	390x410	760x410	1155x410	390x550
Alimentazione / Supply	Gas (1/2")	Gas (1/2")	Gas (1/2")	Gas (1/2")
Voltaggio / Voltage	-	-	-	-
Potenza Elettrica - Electric Power kw	-	-	-	-
Potenza Gas - Gas Power kw	6,9	13,8	20,7	8,5
Consumo metano - mc/h-GPL Kg/h Consumption methane - mc/nh-LPG Kg/h	0,73 / 0,54	1,46 / 1,08	2,19 / 1,52	0,90 / 0,70
Costruzione / Building	Acc. Inox SC Brite Stainless steel Scotch Brite	Acc. Inox SC Brite Stainless steel Scotch Brite	Acc. Inox SC Brite Stainless steel Scotch Brite	Acc. Inox SC Brite Stainless steel Scotch Brite
Grigliato cottura / Grilled cooking	Tondino / Round	Tondino / Round	Tondino / Round	Tondino / Round
Regolazione piani cottura Adjusting device	-	-	-	-
Allaccio idrico / Water connection	-	-	-	-
Carico acqua Water filling	Manuale / Manual	Manuale / Manual	Manuale / Manual	Manuale / Manual
Sonda al cuore / Core probe	-	-	-	-
Volume imballo mc Packing volume mc	0,13	0,21	0,34	0,17
Peso lordo Kg / Gross Weight Kg	30	50	75	35

ACCESSORI / ACCESSORIES

GT35	Grigliato a tondino Serie 350 Gas / Round gridiron Serie 350 Gas
FT155	Fry top Serie 550 GAS / Fry top Serie 550 GAS
GC55-1*	Grigliato a "V" 1/2 modulo serie 550 / Half channeled shaped cooking gridiron 550 series
GT55-1*	Grigliato a tondino 1/2 modulo serie 550 / Half round shaped cooking gridiron 550 series
GDC55-1*	Grigliato a doppia "V" sovrapposta 1/2 modulo serie 550 Half double channeled overlapping shaped cooking gridiron 550 series
FT177	Fry top serie 770GAS / Fry top serie 770 GAS
GT77-1*	Grigliato a tondino 1/2 modulo serie 770 / Half round shaped cooking gridiron 770 series
GDC77-1*	Grigliato a doppia "V" sovrapposta 1/2 modulo serie 770 Half double channeled overlapping shaped cooking gridiron 770 series
GC77-1*	Grigliato a "V" 1/2 modulo serie 770 / Half channeled shaped cooking gridiron 770 series
S12	Kit spiedini per 350 Gas / Kit stainless steel skewers Gas
SSPI	Spazzola / Brush
RAS-GAS	Raschietto per piano gas / Gas scraper
RG 200/R	Kit ruote girevoli (Solo per MR) / Kit wheels (Only for MR)
B-55/77	Gambe per serie EL+GAS 550/770 TOP / Feet for models EL+GAS 550/770 TOP

* Per completare il modulo cottura utilizzare 2 pz

* 2 pieces to cover the all cooking surface



GT55-1 - GT77-1
Dim. 190x400
Dim. 190x560



GC55-1 - GC77-1
Dim. 190x400
Dim. 190x560



GDC55-1 - GDC77-1
Dim. 190x400
Dim. 190x560



FT155 - FT177
Dim. 370x395
Dim. 370x550



B55/77



**GT35 Only for
GV 1035/D**

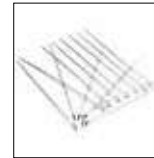

**S12 Only for
GV 1035/D**



RAS-GAS



SSPI



RG 200/R



GV 870 TOP	GV 1270 TOP
Meccanica / Mechanical	Meccanica / Mechanical
800x700x315	1195x700x315
760x550	1155x550
Gas (1/2")	Gas (1/2")
-	-
-	-
17	25,5
1,8 / 1,4	2,7 / 2,1
Acc. Inox SC Brite Stainless steel Scotch Brite	Acc. Inox SC Brite Stainless steel Scotch Brite
Tondino / Round	Tondino / Round
-	-
-	-
Manuale / Manual	Manuale / Manual
-	-
0,30	0,56
70	105

GV 1035/D TOP
Meccanica / Mechanical
1000x350x300
810x250
Gas (1/2")
-
-
8
0,85 / 0,63
Acc. Inox SC Brite Stainless steel Scotch Brite
Optional (2xS12) (2xGTL35)
Si
-
Manuale / Manual
-
0,11
25



MR

**MOBILI PER GRILLVAPOR EL/GAS/TOP
CABINET FOR GRILLVAPOR 700/900**

Mobile Aperto Open cabinet	Dimensioni LxPxH Dimensions
MR455 (455)	420x440x550
MR855 (855)	800x440x550
MR1255 (1255)	1195x440x550
MR470 (470)	420x590x550
MR870 (870)	800x590x550
MR1270 (1270)	1195x590x550

KEEP COOL GRILL FAST

La combinazione di Overgrill e Grillvapor top con le nostre BASI REFRIGERATE è stata ideata per una **perfetta razionalizzazione dello spazio** in cucina.

Considerato che le nostre Grillvapor & Overgrill non interferiscono con la refrigerazione, grazie alla presenza dell'**acqua che isola il calore** nella parte alta dell'apparecchiatura, questa brillante soluzione non solo riduce gli ingombri, ma diminuisce anche gli spostamenti del personale, **abbassa il tempo di produzione, riduce il consumo e lo stress delle celle frigorifere** e diminuisce la possibilità di malattie e infortuni in quanto l'operatore non deve entrare continuamente nella cella. È, inoltre, una soluzione molto **pratica per la pulizia** se montato su ruote.

Le nostre unità di mantenimento sono disponibili con cassetti estraibili Gastronorm 1/1 e con il monoblocco che integra una unità di mantenimento a **temperatura positiva** -2°C/+8°C o **negativa** "freezer" -15°C/-20°C.

The combination of Overgrill and Grillvapor top units with our REFRIGERATED BASES is designed to achieve a perfect **rationalization of space** in the kitchen. Given that refrigeration remains unaffected by our Grillvapor & Overgrill units, thanks to the presence of the **water tray that isolates the heat** in the top part of the equipment, this brilliant solution not only saves space, but also minimizes the distances covered by kitchen staff, **shortens preparation times, rationalizes the use of cold stores by reducing energy usage and thermal stress**, as well as limiting the risk of illness and injury, since the operator is no longer in and out of the cold room continually. This type of solution is also highly **practical for cleaning** purposes, if mounted on wheels. Our cooling units are available with removable Gastronorm 1/1 drawers and with a cabinet that incorporates a refrigeration unit capable of keeping food at **positive temperature** -2°C/+8°C or **negative temperature** (freezer) -15°C/-20°C.

 **ARRIS**[®]
CATERING EQUIPMENT



 **ARRIS**
CATERING EQUIPMENT



KEEP COOL[®]
GRILL FAST





UNITÀ DI MANTENIMENTO / COOLED BENCH

Modello - Model	UM120/2C/TPD	UM120/2C/TND	UM130/2C/TPD	UM130/2C/TND	UM150/2C/TPD	UM150/2C/TND
Tipo - Type	Digitale/Digit	Digitale/Digit	Digitale/Digit	Digitale/Digit	Digitale/Digit	Digitale/Digit
Dimensioni ingombro Overall Dimensions (mm)	1200x680x590	1200x680x590	1300x680x590	1300x680x590	1500x680x590	1500x680x590
Temperatura - Temperature	-2°C/+8°C	-15°C/-20°C	-2°C/+8°C	-15°C/-20°C	-2°C/+8°C	-15°C/-20°C
Vano tecnico Technical compartment	DX	DX	DX	DX	DX	DX
Cassetto 2/3 - GN1/1 - h310 mm Drawer 2/3 - GN1/1 - h310 mm	n°2	n°2	n°2	n°2	n°2	n°2
Alimentazione - Supply	Elettrica/Electric	Elettrica/Electric	Elettrica/Electric	Elettrica/Electric	Elettrica/Electric	Elettrica/Electric
Costruzione - Building	Acc. Inox AISI 304 Sc. Brite	Acc. Inox AISI 304 Sc. Brite	Acc. Inox AISI 304 Sc. Brite	Acc. Inox AISI 304 Sc. Brite	Acc. Inox AISI 304 Sc. Brite	Acc. Inox AISI 304 Sc. Brite
Potenza assorbita kW Absorbed power kW	0,250	0,465	0,250	0,465	0,250	0,465
Voltaggio/ Voltage	230V/50Hz (60Hz on request)*	230V/50Hz (60Hz on request)*	230V/50Hz (60Hz on request)*	230V/50Hz (60Hz on request)*	230V/50Hz (60Hz on request)*	230V/50Hz (60Hz on request)*
Resa frigorifera W Yeld Cooling W	565	616	565	616	565	616
Gas refrigerante Refrigerant Gas	R404a	R404a	R404a	R404a	R404a	R404a
Kit ruote girevoli - Kit wheels	Optional RG100/4	Optional RG100/4	Optional RG100/4	Optional RG100/4	Optional RG100/4	Optional RG100/4
Volume - Volume	0,80	0,80	0,90	0,90	0,95	0,95
Peso lordo - Gross weight	90	90	100	100	115	115

kit N°4 ruote girevoli / kit N°4 wheels



UNITÀ DI MANTENIMENTO / COOLED BENCH

Modello - Model	UM160/3C/TPD	UM160/3C/TND	UM180/3C/TPD	UM180/3C/TND
Tipo - Type	Digitale/Digit	Digitale/Digit	Digitale/Digit	Digitale/Digit
Dimensioni ingombro Overall Dimensions (mm)	1600x680x590	1600x680x590	1800x680x590	1800x680x590
Temperatura - Temperature	-2°C/+8°C	-15°C/-20°C	-2°C/+8°C	-15°C/-20°C
Vano tecnico Technical compartment	DX	DX	DX	DX
Cassetto 2/3 - GN1/1 - h310 mm Drawer 2/3 - GN1/1 - h310 mm	n°3	n°3	n°3	n°3
Alimentazione - Supply	Elettrica/Electric	Elettrica/Electric	Elettrica/Electric	Elettrica/Electric
Costruzione - Building	Acc. Inox AISI 304 Sc. Brite	Acc. Inox AISI 304 Sc. Brite	Acc. Inox AISI 304 Sc. Brite	Acc. Inox AISI 304 Sc. Brite
Potenza assorbita kW Absorbed power kW	0,282	0,650	0,282	0,650
Voltaggio/ Voltage	230V/50Hz (60Hz on request)*	230V/50Hz (60Hz on request)*	230V/50Hz (60Hz on request)*	230V/50Hz (60Hz on request)*
Resa frigorifera W Yeld Cooling W	565	782	565	782
Gas refrigerante Refrigerant Gas	R404a	R404a	R404a	R404a
Kit ruote girevoli - Kit wheels	Optional RG100/4	Optional RG100/4	Optional RG100/4	Optional RG100/4
Volume - Volume	1,0	1,0	1,1	1,1
Peso lordo - Gross weight	120	120	140	140

kit N°4 ruote girevoli / kit N°4 wheels

UNITÀ DI MANTENIMENTO / COOLED BENCH

Modello - Model	UM220/4C/TPD	UM220/4C/TND
Tipo - Type	Digitale/Digit	Digitale/Digit
Dimensioni ingombro Overall Dimensions (mm)	2200x680x590	2200x680x590
Temperatura - Temperature	-2°C/+8°C	-15°C/-20°C
Vano tecnico Technical compartment	DX	DX
Cassetto 2/3 - GN1/1 - h310 mm Drawer 2/3 - GN1/1 - h310 mm	n°4	n°4
Alimentazione - Supply	Elettrica/Electric	Elettrica/Electric
Costruzione - Building	Acc. Inox AISI 304 Sc. Brite	Acc. Inox AISI 304 Sc. Brite
Potenza assorbita kW Absorbed power kW	0,37	1,0
Voltaggio/ Voltage	230V/50Hz (60Hz on request)*	230V/50Hz (60Hz on request)*
Resa frigorifera W Yeld Cooling W	656	935
Gas refrigerante Refrigerant Gas	R404a	R404a
Kit ruote girevoli - Kit wheels	Optional RG100/6	Optional RG100/6
Volume - Volume	1,3	1,3
Peso lordo - Gross weight	160	160

kit N°6 ruote girevoli / kit N°6 wheels

CONTROLLO COMPLETO DEL PROCESSO DI COTTURA

Complete control of the cooking process



Alcuni esempi di Monoblocco che integrano una unità di mantenimento a temperatura positiva -2°C/+8°C o negativa "freezer" -15°C/-20°C con zona cottura sovrapposta Overgrill®, Grillvapor® e/o FRY TOP*

Flessibile: disponibile in varie dimensioni e soluzioni per ogni specifica esigenza di cottura, la base può essere montata su ruote per facilitare la pulizia.
Produttivo: massima produttività, minore sprechi eliminando il tempo per recuperare i cibi dal frigo o dal "freezer". Riduzione al 50% dei tempi di cottura di qualsiasi cibo e riduzione del costo della manodopera.
Ingombri: le migliori prestazioni e funzionalità nei minimi ingombri da 0,72 ad 2 mq.
Stoccaggio: le unità di mantenimento sono disponibili con cassetti estraibili Gastronorm 1/1.

Some examples of single unit which include one cooled bench with positive temperature -2°C/+8°C or negative temperature "freezer" -15°C/-20°C and overlapped cooking zone with Overgrill®, Grillvapor® and Fry Top*

Flexible: for every specific requests of cooking there is the solution available in various dimensions. The cooled bench may have the wheels in order to make easier the cleaning procedures.
Productive: high performance, low wastefulness. With this solution the time used to catch the food from the fridge or from the freezer will be cancelled. 50% of reduction in cooking time of every type of food and reduction of cost of labour.
Dimensions: the highest performance in minimum space from 0,72 to 2 mq. **Storage:** the cooled benches are available with removable drawers Gastronorm 1/1

Caratteristiche unità di mantenimento:

- Esterno /interno acciaio inox AISI 304.
- Spessore isolamento 50 mm.
- Angoli interni ed esterni arrotondati.
- Guarnizioni magnetiche sostituibili.
- Sistema anticondensa cornice cassetto (unità negativa).
- Refrigerazione ventilata.
- Unità condensante tropicalizzata.
Funzionamento garantito fino a +43°C ambiente.
- Sbrinamento automatico a gas caldo.
- Evaporazione automatica della condensa.
- Conformità HCCP.
- Piedini in acciaio inox.
- Quadro comandi elettronico semplice ed intuitivo.
- Memorizzazione temperatura massima.

* Possibilità di installare tutte le versioni Overgrill®, Grillvapor® e Fry Top con eventuale piano di lavoro neutro esclusi i modelli con allacciamento idrico Serie 700. Realizzazioni su misura.

Cooled bench features:

- Outer/inner parts in stainless steel AISI 304.
- Insulation thickness 50 mm.
- Rounded outer and inner edges.
- Replaceable magnetic seals.
- Drawer frame anticondensation system (negative cooled bench).
- Aired refrigeration.
- Warm condensation unit. Guaranteed working to +43°C.
- Automatic defrosting with hot gas.
- Automatic evaporation of condensation.
- Conformity HCCP.
- Feet in stainless steel.
- Easy electronic control panel.
- Maximum temperature memorisation.

* It is possible to install all versions of Overgrill®, Grillvapor® and Fry Top with eventual neutral working zone except models with water connection Serie 700. Custom-made.

Piano neutro / Neutral cabinet



PN40

Piano appoggio con mobile neutro appoggio teglie dim. 400x600x400
Support surface for dishes and pots with neutral cabinet dim. 400x600x400

PN20

Piano appoggio con mobile neutro appoggio teglie dim. 200x600x400/
Support surface for dishes and pots with neutral cabinet dim. 200x600x400

PN30

Piano appoggio con mobile neutro appoggio teglie dim. 300x600x400 /
Support surface for dishes and pots with neutral cabinet dim. 300x600x400

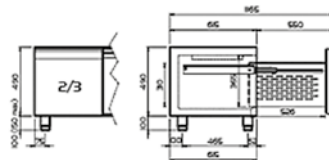

- Dettaglio cassetti da 2/3 GN1/1 installati di serie / Drawers details of 2/3 GN1/1 standard supply

- Vano tecnico DX di serie (SX optional da specificare all'ordine senza variazione di prezzo) / Technical compartment DX standard supply (SX optional to be specified at the moment of the order. No change in price)





ARRIS AGER

DAI UN VALORE AGGIUNTO ALLA TUA CARNE

GIVE AN ADDED VALUE TO YOUR MEAT

Il nuovo **ARRIS AGER** è un frigo di maturazione per la carne in grado di controllare l'umidità dal 50% - 85% e la temperatura dai 0°C a 10°C tramite un controllo digitale che permette di avere a portata di mano tutti i valori della apparecchiatura e gestire la pianificazione della tua frollatura. Ottieni il massimo da ogni singolo pezzo di carne ed offri al tuo cliente la possibilità di gustare una carne estremamente morbida e saporita grazie al semplice ma efficiente programma di maturazione. L'azione di maturazione dell' ARRIS - AGER utilizza i nostri blocchi di sale dell' himalaya che permettono di abbassare la percentuale di umidità fino al 35%. Questo può essere gestito liberamente dall'utilizzatore in quantità e tipologia per dare la propria personalizzazione al processo di maturazione lasciando così libero sfogo alla vostra creatività.

The new **ARRIS AGER** is a dry aging equipment that can control the humidification from the 50%-85% and the temperature between 0°C to 10°C thanks to an electronic control that allows to check in every moment all the values of the equipment and the planning of the maturation. Take the best from every single piece of meat and give your customer the experience to taste an extremely soft and flavored meat, thanks to the simple but efficient process of maturation. The action of ARRIS AGER uses our Himalayan salt blocks that allows to reduce by the 35% the percentage of humidity. This can be managed freely in quantity and in typology by the users in order to give a personalization to the out-process and free the creativity

DESCRIZIONE / MODELLO	CODICE CODE		AA 85135	AA 85210
Dimensioni esterne - Overall Dimensions		mm	810x500x1350	810x500x2100
Porte - Doors		n.	1	1
Tipo refrigerazione - Refrigeration type			Ventilata / Ventilated	Ventilata / Ventilated
Temperatura - Temperature		°C	0 / 10°	0 / 10°
Umidità relativa - Relative humidity		%	50 / 85	50 / 85
Sistema di sbrinamento - Defrosting system			Automatico a sosta Automatic stop	Automatico a sosta Automatic stop
Potenza massima assorbita - Max absorbed power		W	780	930
Potenza refrigerante - Cooling power		W	246	246
Gas refrigerante - Refrigerant gas			R134a	R134a
Rumorosità unità condensatrice - Condenser unit noise level			<43dba	<43dba
Classe climatica- Climate class			4	4
Voltaggio - Voltage		V	230V/50Hz	230V/50Hz
Dotazione Set Sale Himalaya - Equipment Set Himalaya Salt	SHAA		N°3 lastre cm 20x10x2,5 N°3 plates 20x10x2.5 cm	N°3 lastre cm 20x10x2,5 N°3 plates 20x10x2.5 cm

Imballo in pallet e cartone inclusi / Packaging in pallets and carton included

Accessori / Accessories	CODICE CODE	AA 85135	AA 85210
Ripiani intermedi consigliati (Portata circa 20 Kg ciascuno) <i>Recommended intermediate shelves (about 20 Kg each)</i>		N° 2	N° 5
Strumento di misura PH - PH measuring instrument	PH80		
N° 1 Ripiano intermedio forato acc. Inox <i>N° 1 Intermediate shelf drilled stainless steel</i>	RAA80		
N° 1 Struttura sostegno carni in acc. Inox con 2 tubi e 3 ganci inclusi - N° 1 meat support structure in stainless steel with 2 tubes and 3 hooks included	GAA80		
Gancio in acciaio inox - <i>Stainless steel hook</i>	GGAA		



AA 85135

AA 85210



AA 85210

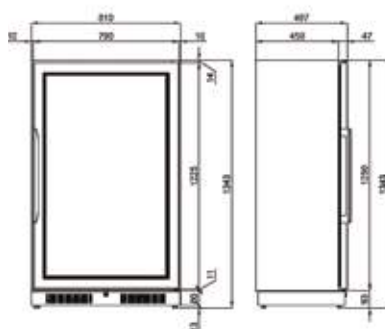

AA 85135

